

75 cents

hcr

focus
on
communications
technology . . .

ham radio

magazine

FEBRUARY 1970

144- AND 432- MHz

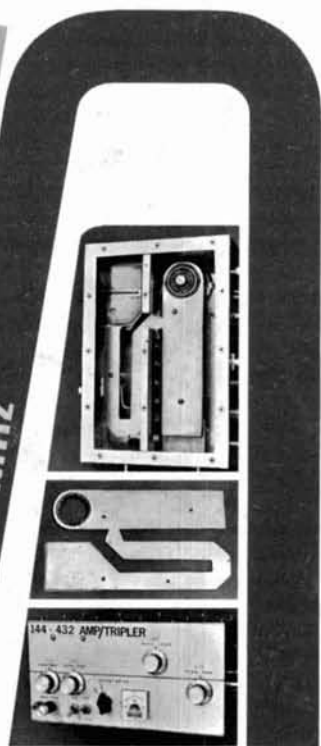

DUAL-BAND STRIPLINE AMP/TRIPLER

this month

- vhf fm transmitter 18
- solid-state power supplies 25
- modulating transistor power amplifiers 50
- low-frequency antennas 55

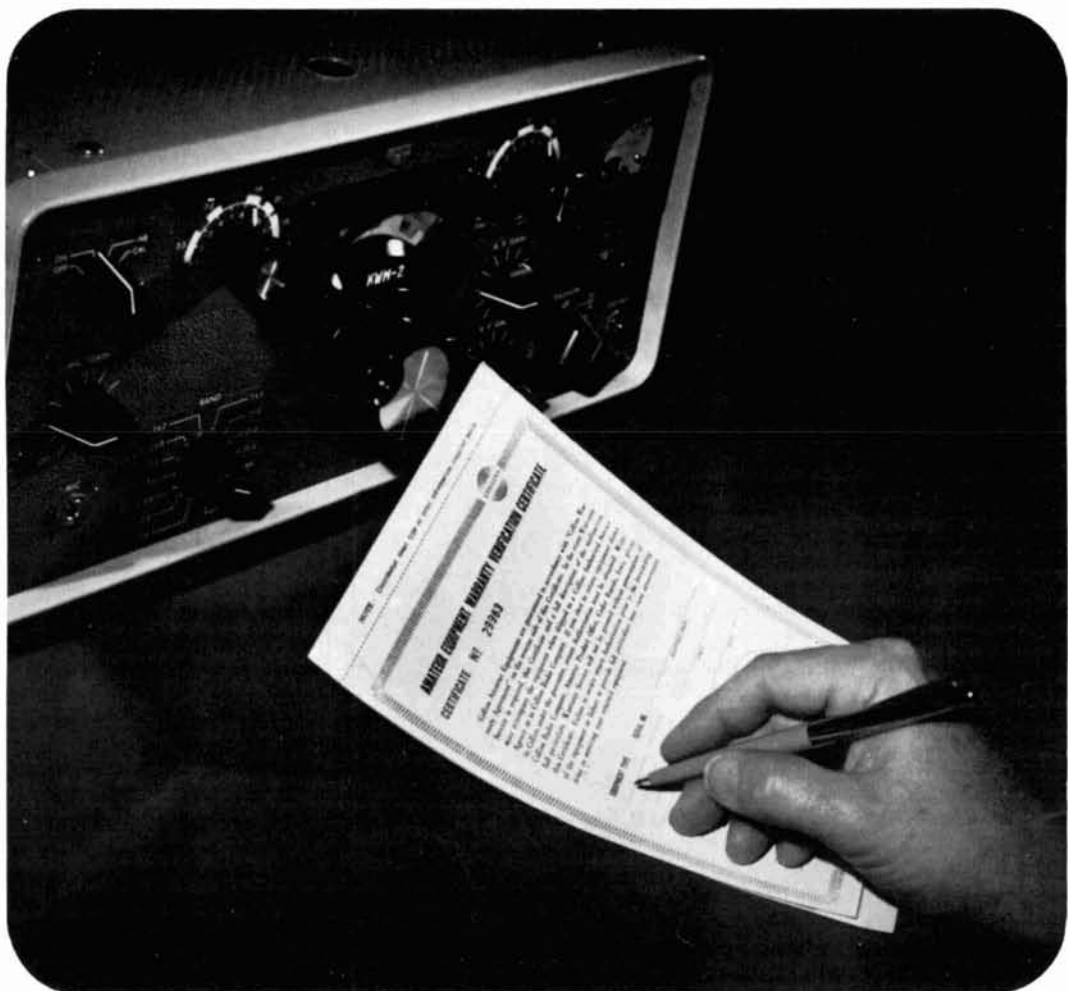

Now a full year warranty on Collins equipment

Collins S-Line and KWM-2 have long been standards of excellence in the amateur radio world. Now, Collins backs up its quality equipment with a full one-year warranty.

Collins equipment has proved its dependability in millions of hours of trouble-free operation in ham shacks around the world, and under rugged field conditions. And Collins proves its value again at trade-in time.

See the S-Line and KWM-2 at your Collins distributor. Examine the fine craftsman-

ship. Look over the specs. Read the full one-year warranty. You'll see why Collins is the standard of quality in the amateur field.

Collins S-Line and KWM-2 are examples of engineering and manufacturing excellence achieved at Collins through use of the C-System.

See Collins equipment at the SSB Show, Statler Hilton, New York, March 24.





**Bob Eshleman, W4QCW,
earns top Five Band DXCC Award and his
“trusty” 2-K amplifier was with him all the way!**

Most amateurs dream of being number ONE. Few have the opportunity. W4QCW was ready. Bob had the skill, the patience and he had the fine equipment he needed. At Henry Radio we are proud the 2-K helped W4QCW win this unique honor.

Like Bob Eshleman you can own a big 2-K signal. Three thousand discerning amateurs throughout the world are solving their communications problems with 2-K's---the “clean signal” amplifier. For maximum power, maximum linearity and maximum value the answer is obviously the 2K-3. \$745.00 Floor console or Desk model.

EASY FINANCING • 10% DOWN OR TRADE-IN DOWN • NO FINANCE CHARGE IF PAID IN 90 DAYS • GOOD RECONDITIONED EQUIPMENT • Nearly all makes and models. Our reconditioned equipment carries a 15 day trial, 90 day warranty and may be traded back within 90 days for full credit toward the purchase of NEW equipment. Write for bulletin. Export inquiries invited.

TED HENRY (W6UOU)

BOB HENRY (WØARA)

WALT HENRY (W6ZN)

Henry Radio

11240 W. Olympic Blvd., Los Angeles, Calif. 90064

213/477-6701

931 N. Euclid, Anaheim, Calif. 92801 714/722-9200

Butler, Missouri 64730

816/679-3127

Henry Radio has representatives in different areas of the U.S. to simplify ordering for those living near one. Or you can order direct and we will ship... across the street or around the world. Call or write for specifications and terms.

Texas area: Stewart E. Fason, W5RER

New York area: John Richardt, W2WIY

Chicago area: Bill Reynolds, K9ZXD

Attention: Military and commercial users.

The new 3K amplifier is now available for continuous duty high power RTTY and extra power SSB operation. \$895.00 F.O.B. Los Angeles, Calif.



- Direct Frequency Dialing
 - Programmable Coverage
- ## COMMUNICATIONS RECEIVER
- All Solid State
 - FET Circuitry



MODEL SPR-4... \$379⁰⁰ NET



Precision tuning dial . . .
tune station frequency directly
. . . no searching.



Programmable frequency
coverage . . . change crystal
and label on dial.

For more information write

The SPR-4 is a general purpose receiver which may be programmed to suit any interest: SWL, Amateur, Laboratory, Broadcast, Marine Radio, etc. Frequency Coverage: 150-500 KHz plus any (23) 500 KHz ranges between .500 and 30 MHz.

FEATURES: • Linear dial with 1 KHz readout • 4-pole crystal filter in first IF • 4-pole LC filter in second IF • Three bandwidths: 0.4 KHz, 2.4 KHz, and 4.8 KHz for: CW, SSB, AM • AVC time constants optimized for each mode • Superior cross-modulation and overload performance • Power: 120 VAC, 220 VAC, and 12 VDC • Crystals supplied for LW, standard broadcast and seven shortwave broadcast bands • Built-in speaker • Notch Filter.

ACCESSORIES: 100 KHz calibrator, noise blanker, transceiver adapter (T-4XB), DC power cord, loop antenna, crystals for other ranges.

R. L. DRAKE COMPANY
540 Richard St., Miamisburg, Ohio 45342

february 1970
volume 3, number 2

staff

James R. Fisk, W1DTY
editor
Nicholas D. Skeer, K1PSR
vhf editor
J. Jay O'Brien, W6GDO
fm editor

A. Norman Into, Jr., W1CCZ
Alfred Wilson, W6NIF
James A. Harvey, WA6IAK
associate editors

Jean Frey
art director
Wayne T. Pierce, K3SUK
cover

T. H. Tenney, Jr., W1NLB
publisher

offices

Greenville, New Hampshire 03048
Telephone: 603-878-1441

ham radio magazine is
published monthly by
Communications Technology, Inc.,
Greenville, New Hampshire 03048

Subscription rates, world wide:
one year, \$6.00, three years, \$12.00.
Second class postage
paid at Greenville, N.H. 03048
and at additional mailing offices.

Foreign subscription agents:
United Kingdom:
Radio Society of Great Britain,
35 Doughty Street, London WC1, England.

All European countries:
Eskil Persson, SM5CJD, Frotunagrand 1,
194 00 Upplands Vasby, Sweden.

Copyright 1970 © by
Communications Technology, Inc.
Title registered at U. S. Patent Office.
Printed by Capital City Press, Inc. in
Montpelier, Vermont 05602, U.S.A.

ham radio is available to the blind
and physically handicapped on magnetic tape
from Science for the Blind,
221 Rock Hill Road, Bala Cynwyd,
Pennsylvania 19004.
Microfilm copies of current
and back issues are available
from University Microfilms,
313 N. First Street, Ann Arbor,
Michigan 48103.

Postmaster: Please send form 3579 to
ham radio magazine, Greenville,
New Hampshire
03048.



contents

- 6 stripline amplifier/tripler for 144/432 MHz**
Richard T. Knadle, Jr., K2RIW
- 18 fm transmitter for two meters**
Frank C. Jones, W6AJF
- 25 solid-state power supplies**
Henry D. Olsen, W6GXN
- 40 improving the reliability of pilot lights**
F. J. Case, W3NK
- 42 tilt-over antenna mast**
Sidney Wald, W6KRT
- 50 modulating solid-state rf power amplifiers**
Courtney Hall, WA6SNZ
- 55 antenna systems for 40 and 80 meters**
E. H. Conklin, K6KA
- 64 rapid vhf band changes**
W. G. Eslick, KØVQY
- 4 a second look**
- 94 advertisers index**
- 72 comments**
- 83 flea market**
- 66 ham notebook**
- 76 new products**

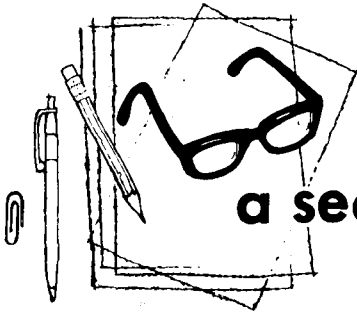

a second look

by Jim Fisk

One of the most devastating experiences that could befall a ham is to lose an expensive tower and antenna during a storm. What's even worse is to be forced to dismantle an antenna installation because of some overlooked restriction pertaining to a local zoning law or building ordinance.

Hams often erect antennas and install electrical wiring at a new location in their eagerness to get on the air, only to receive a "cease and desist" order from local authorities because of some oversight. If you plan to rent, lease, or buy a choice piece of real estate that promises to be the answer to a dream location, it's well to examine the fine print in all legal documents associated with the transaction **before** you sign anything.

In many parts of the country, local building codes contain restrictions against the installation of "radio transmitting apparatus and appurtenances thereto." Such restrictions are often included in lease agreements, title insurance policies, and grant deeds.

Housing developments are becoming a part of the more densely populated areas of the country. Property deeds in these developments often prohibit installation of "structures that conflict with the existing and planned decorative ensemble," or similar phraseology. The language of these documents is often made vague for a purpose: the development planners (and your neighbors) can then ban any structure they might consider to be at variance with local architectural and landscaping motifs. Such structures might include anything from chicken coops to your \$500 antenna installation.

Before buying or leasing property, make certain a clause is added to the legal documents that will allow you to install a tower and antenna. It's a good idea to enlist the

services of an attorney to help you word the clause, otherwise loopholes may exist that will cause all kinds of problems. The small fee for the attorney's help is well worth the peace of mind after you sign on the dotted line.

As a first approach, consult your local radio club. In most large cities, ham clubs are represented by people who are knowledgeable in this area, or have members who can steer you in the right direction. In California, for example, the Los Angeles Council of Radio Clubs has a service that provides answers to questions from any ham regarding the specific language in a clause to be added to a real estate document. This service is provided gratis by W6QJW and WA6ZCO as a contribution to amateur radio. Many other cities have similar services.

Sometimes electrical and building codes aren't included in real estate documents; nevertheless they're still a part of local law. These ordinances should be thoroughly investigated before you add anything to your property. You might take a tip from the experience of one ham who installed a heavy-duty 220-volt circuit between the power company's service drop and his kilowatt transmitter. Not only did he neglect to obtain a construction permit he also tied several guy wires from his tower to a power company utility pole. He was doing great in a DX contest one day when he was visited by a representative of the local sheriff's office. Sure enough, he was presented with a "cease and desist" order that required him to disassemble his tower and the 220-volt line to his rig. This chap finished the DX contest with an indoor dipole antenna and a healthy respect for local ordinances.

Jim Fisk, W1DTY
editor



Here's the exciting new Heath SB-220 2 kW Linear Amplifier. Running maximum legal power on amateur bands between 80 and 10 meters, this compact powerhouse features two

rugged EIMAC 3-500Z zero bias triodes in proven grounded grid circuitry. Note the modern desktop styling and the heavy duty components. And note the use of the reliable 3-500Zs. Heath chose EIMAC because these dependable tubes are ideal for heavy-duty operation, around the clock, around the world. And the two tubes have a total plate dissipation rating of 1000 watts.

Heath's choice is your choice. Go EIMAC. Look for the equipment featuring EIMAC power tubes.

The 3-500Z is one of EIMAC's family of zero bias power triodes: from 400 watts to 50 kW. Contact your distributor or a Varian/Eimac Field Office for further information. Offices are located in 16 major cities. Ask information for Varian Electron Tube and Device Group. Or write Amateur Services Department, Eimac Division of Varian, San Carlos, Calif. 94070.



EIMAC 3-500Zs are Heath's Choice.



dual-band stripline amplifier/tripler for 144 and 432 mhz

This state-of-the-art
stripline amplifier
provides an effective
efficient way
to get on
two popular
vhf bands

Richard T. Knadle, Jr., K2RIW, Airborne Instruments Laboratory, Deer Park, Long Island, New York 11729

Here is an easy way to update your present 2- to 20-watt two-meter exciter and get on 432 MHz at the same time. Bandswitching is accomplished merely by adjusting the tuning controls on the front panel.

The 500 watt capability on two meters is more than enough for most serious vhf enthusiasts, while the 80 watts available on 432 MHz is a respectable output and will give ample drive for almost any kilowatt final you may build.

The stripline tuned circuits used in this unit yield high Q and result in well-shielded cavities although common aluminum chassis are used throughout. Furthermore, this amplifier/tripler can be reproduced with little difficulty—all cavity parts are made from ordinary flat material with a nibbling tool.

The unusual grid circuit allows independent adjustment of the resistive and reactive



components so that the input to the amplifier can be made to look like 50 ohms. This is an important factor when driving an amplifier with a transistorized 2-meter transmitter since transistors are vulnerable to a high swr load.*

The stripline technique is a modern cavity approach you have probably seen before,^{1,2,3,4} and I suspect you will see more of it in the future. Theory of operation is almost identical to coaxial cavities, but striplines are much easier to build, often provide higher Q's, and have some flexibilities which do not exist with conventional cavities. For ex-

conveniently be made very wide, which keeps losses down.

operation

The plate circuit for 432, consisting of L1 and C1, is a half-wavelength resonator with a "flapper" variable capacitor for tuning (fig. 1). At the voltage nodal point on L1 where an rf choke for feeding in B+ would normally be connected, a folded half-wavelength line is used instead (L2 and C2, resonant at 144 MHz). If the nodal point on L1 is correctly chosen, the 144-MHz line causes no compromise on 432 MHz.

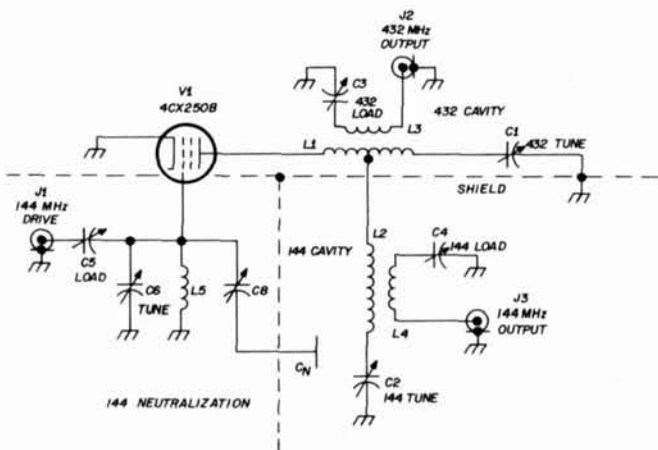
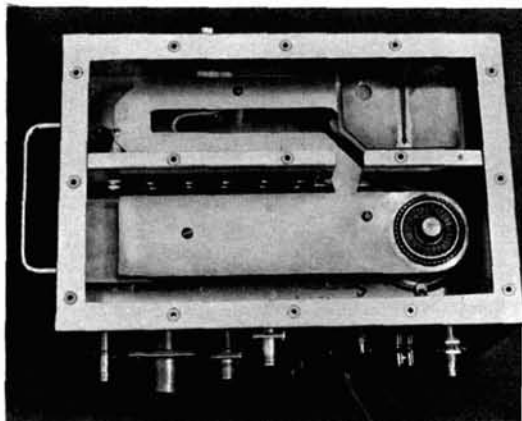

fig. 1. Simplified schematic diagram of the grid and plate circuits of the 144/432 MHz amplifier/tripler.

ample, continuously tapered lines are easy to build with stripline, but picture the plight of an amateur searching for continuously tapered pieces of tubing if he were using normal coaxial cavities for an amplifier like this one.

The stripline is placed midway between the ground planes in this amplifier/tripler so equal rf currents flow along both sides of the conductor and full advantage is taken of the stripline technique. In ordinary coaxial cavities, as with stripline, rf currents only flow along the outer surface of the inner conductor; with stripline this conductor can

Inside view shows positioning of copper-clad stripline. Part of L4 is visible inside the bend of the 144-MHz line in the upper left-hand corner; C1 is in the lower left.



* I drive the amplifier/tripler with a solid-state 20-watt-output 2-meter nbm transmitter that uses one 530-type transistor. I will be glad to send you a schematic diagram for a self-addressed, stamped envelope.

The components of the 432 cavity act as stray capacitance to the 2-meter cavity, and slightly increases current in the 2-meter section. The inherent high Q of the stripline and the demonstrated efficiency of 75 percent on 2 meters indicates that this is not a problem.

When you desire 432 MHz operation, L1 and C1 are resonated to 432, and the 2-meter cavity is tuned off resonance by minimizing the flapper capacitor C2. The output loop L3 and C3, tuned to 432 MHz, supplies 432 MHz energy to J2.

When two-meter operation is desired, the 432 cavity is tuned off resonance by minimizing C1, and the two-meter cavity is resonated with C2. The output loop L4 and C4, tuned to 144 MHz, supplies output to J3.

The shield between the two cavities and the individually-tuned pick-up loops minimize undesired output frequencies. In addition, the shield breaks the box into two smaller chambers that greatly reduces the possibility of a higher mode resonance; this danger exists whenever two dimensions of a box approach one half wavelength, and this little-known factor has often frustrated amateurs. When it occurs, you can't make the cavity resonate at the correct frequency,

Grid-circuit layout. Inductor L5 is above socket; C5 and C6 are stacked to the right. The C2 tuning mechanism is in the lower right-hand corner. Stiff wire in lower center is part of neutralizing network.

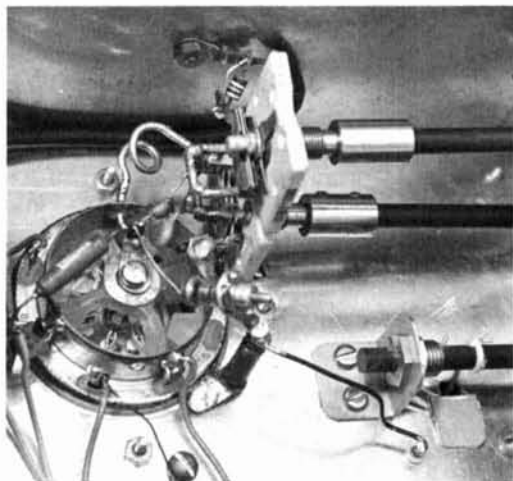

find the correct position of the output coupling loop for proper loading, or make push-pull finals share the load equally. When the box itself resonates, it is usually unloaded and has a higher Q than the resonator inside; this causes the box resonance to predominate. All in all, you are safer if you keep boxes small.

I think it's time that amateurs try something besides link-coupled grid circuits. Motorola has an excellent application note⁵ which describes a number of matching circuits and gives values for 50-ohm systems. Although intended for transistor applications, they are applicable to tubes as well. The circuit I used allows the resistive and reactive component to be adjusted over a large range. It is reassuring to put an swr meter between the driver and final and be able to adjust for a 1:1 match at all reasonable drive levels.

During two-meter operation, the grid of a 4CX250B looks like 16 pF in parallel with a 3k resistor. With the greater bias and drive used for tripler operation, this resistance goes up to about 14k. The schematic of the grid circuit is as follows:

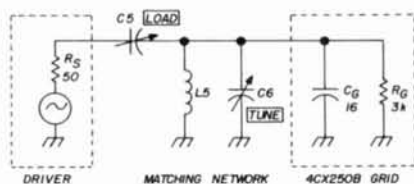

Capacitor C5 controls the transformation ratio (loading) and C6 controls the reactive component (tuning). The values in fig. 2 have enough range for operation on either 144 or 432 MHz. Some stretching or squeezing of L5 may be required to center the tuning of C6. C7 in series with C5, merely sets the range of C5. The resultant grid circuit has a loaded Q of 20 for 144 MHz operation and 75 for 432 MHz operation.

construction

The amplifier/tripler is built in two 8x12x3-inch chassis screwed together top to bottom. The top of the upper chassis is nibbled away, leaving a 3/4-inch wide mounting surface for the cover plate. The tube socket hole is drilled 2-7/8-inches from the

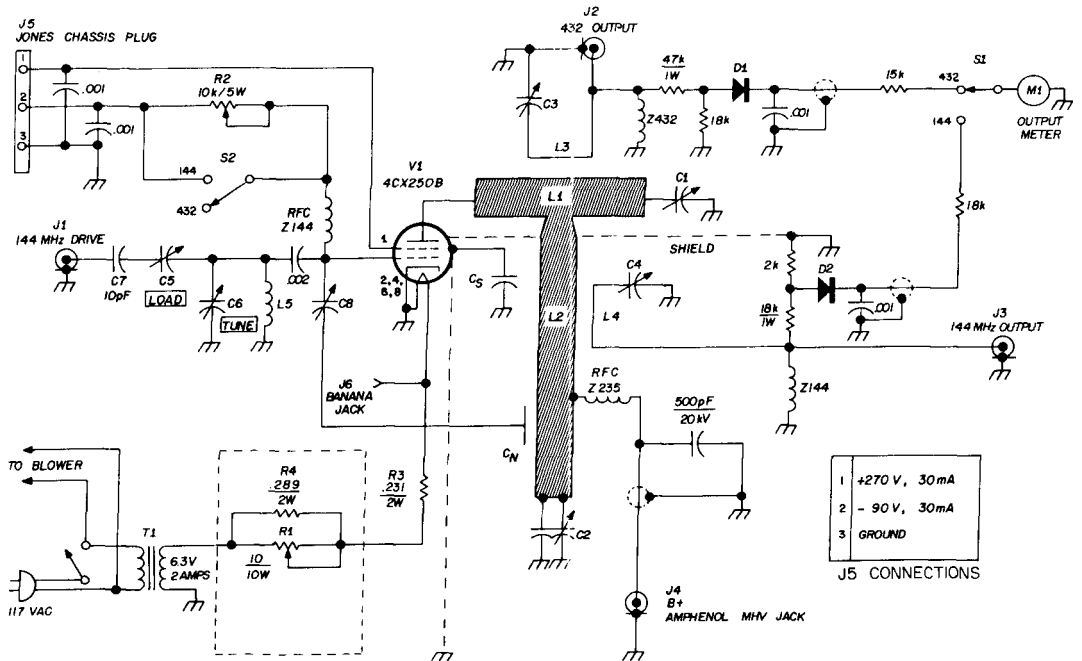

- C1, C2 Stripline flapper capacitors; see fig. 6
- C3 0.4-8 pF piston (JMC 1802). APC types do not function well here
- C4 25 pF air variable (APC-25)
- C5, C6 17.5 pF air variable (HF-15)
- C8 0.5-3 pF piston (JFD VC25G)
- C_S Screen bypass capacitor, part of the tube socket
- C_N Neutralizing capacitor, 3/4" diameter brass plate, 1/2" from L2 in vicinity of C2.
- D1 hot carrier diode (Hewlett-Packard HP-2301)
- D2 Fairchild FD-100
- L1, L2 Stripline inductors, see fig. 4
- L3, L4 Output coupling loops, see fig. 5
- L5 1 1/2 turns no. 12, 5/16" diameter, 1/2" long, with 1/2" lead length
- R3 5 feet no. 22 wire, coiled
- R4 17.5 feet no. 22 wire, coiled
- T1 6.3 volt, 3A transformer (UTC S-55)

fig. 2. Complete schematic diagram of the amplifier/tripler. Resistor R3 should be 0.08 ohm.

rear of the chassis and 2-1/8-inches from the left side. One side of a third 8x12x3-inch chassis was sawed off and shortened slightly to serve as the shield between the two cavities (fig. 3).

A less expensive approach would be to bend this shield from a piece of sheet aluminum, but I didn't have a sheet metal brake available. The shield is located 4-1/4-inches from the rear of the chassis. Some of the holes in the shield were positioned to optimize cooling of the two-meter stripline. Subsequent tests have shown that this was not required. The hottest point on the two-meter line runs 50° C hotter than the cooling air.

I used 6-32 bolts and blind Bendix rivnuts for fastening the top plate. This was done because it was necessary to remove the top cover many times during the stripline trimming process. However, now that the design is completed, self-tapping sheet-metal screws should serve nicely. The stripline is built from a single 6x10-inch piece of 1/16-inch double-sided two ounce copperclad epoxy-fiberglass board (fig. 4).

This material was used because it is easy to cut and solder. The conductor thickness is more than adequate since rf current skin depth in copper at 144 and 432 MHz is 0.218 and 0.125 mils respectively. Almost any rigid material with a copper thickness

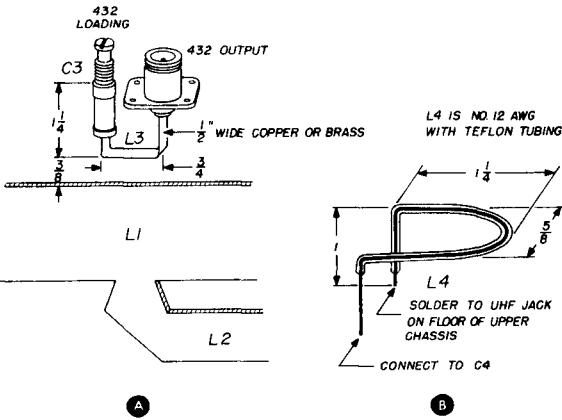

fig. 5. Output coupling loops. Capacitor C4 is mounted on the front of the amplifier 2-1/8" below the top and 3-7/8" in from the right side. L4 loop is positioned 1/2" from inside bend of L2.

ponents. The screening was first tinned around the edges; the inside of the hole was tinned with aluminum solder using a soldering iron attachment on a butane torch. It was then easy to tack the screening in place with the iron attachment and torch.

tuning capacitors

The flapper capacitors C1 and C2 are built as shown in fig. 6. They are made from spring brass; the dial cord is brought through a small hole in the chassis and wrapped around a bakelite rod which extends through the front panel. Drilling a small hole in the rod and tying the dial cord through it avoids any slippage. If the two holes through the chassis are small enough, there's almost no loss of cooling air. **Do not** use metallic dial cord.

The bakelite rods are each supported by two shaft bushings which are intentionally misaligned to cause friction so that the capacitor will hold its setting. A sheet of 10-mil Mylar film glued to the top surface of each flapper with silicone rubber adhesive insures that a high-voltage short will not occur if the flapper touches the stripline.

Capacitor C2 consists of the variable flapper on the bottom of the stripline and a fixed but semi-adjustable capacitor plate on the top side. It is properly adjusted when

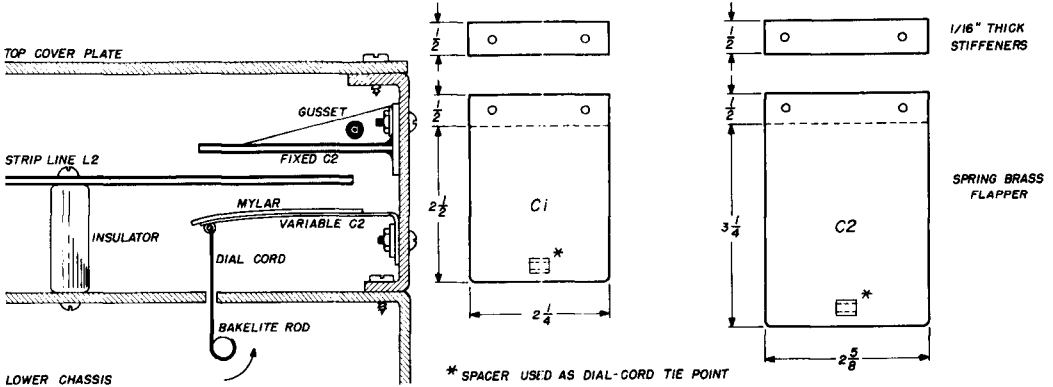
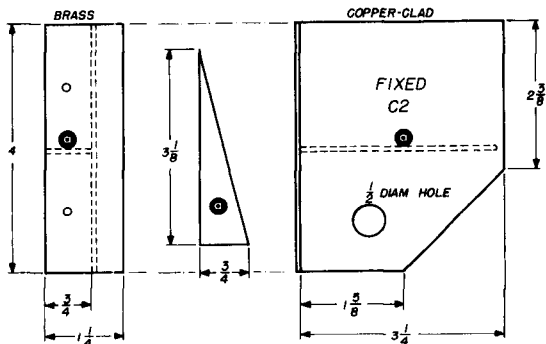

fig. 6. Construction of variable capacitors C1 and C2. For installation, 6-32 nuts are soldered to the brass stiffeners and the mounting plate for the fixed portion of C2. The C1 flapper is located 3/8" below L1; C2 flapper is 1/4" below L2 and the fixed portion of C2 is 3/16" above L2. The fixed portion of C2 is shown bolted to the side of the chassis for illustration—it is actually bolted to the front of the chassis as shown in the photo. The 1/2" hole in the fixed portion of C2 is centered on the stripline mounting bolt.



the two-meter line resonates with equal spacings of these two capacitor plates—approximately 3/16 inch.

power supplies

A 500-watt input on 144 MHz requires 5.2 watts drive and +2000 volts at 250 mA, +270 volts at 30 mA and -90 volts bias; 80 watts output as a 432-MHz tripler requires

than 375 watts output may be obtained. The -90V grid-bias supply makes adjustments easier and eliminates the need for B+ relays. When drive is removed, the tube turns off, even though B+ and screen voltage are still present.

The 4CX250B filament is designed for 6.0 volts; a dropping resistor of 0.08 ohms must be used if a 6.3-volt transformer is

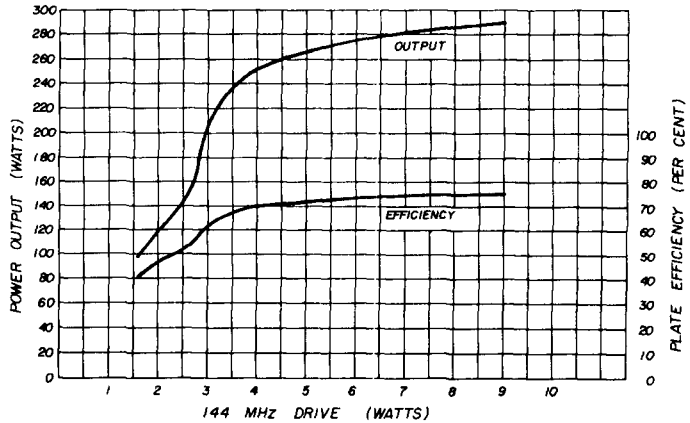
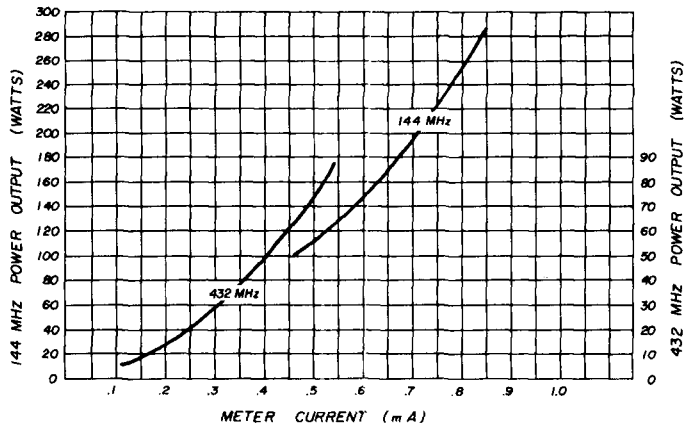

fig. 7. Operating characteristics of the hot-carrier diode output meter.

20 watts of two-meter drive and 1400 volts B+. Less drive will still give acceptable results as fig. 8 and 9 illustrate. These measurements were made with a used 4CX250B tube in the final. All power measurements were made with +1400 volts supply, the limit of my high-voltage power supply. If you use a 2000 volt supply for two-meter operation, efficiency will be slightly higher, and greater

used. This 2-watt resistance is simply formed with a 5-foot length of no. 22 wire coiled around a suitable form. An optional wire-wound potentiometer allows decreasing the 6.0-volt filament voltage to 5.5-V for 432-MHz operation. The back-bombardment of the cathode caused by 20 watts drive causes considerable heating, and decreased filament voltage will extend tube life.

fig. 8. Operational characteristics of the amplifier/tripler when used as a 144-MHz amplifier with B+, 1400 V, screen voltage, 270 V, and grid bias, -90 V. Higher output and efficiency can be obtained with 2000 volts B+.



On the subject of 4CX250B's, I have found that many of these tubes will blow the screen-grid and plate fuses when excitation is first applied. This may happen two or three consecutive times, and after that no trouble is experienced for hundreds of hours. I suspect that small pieces of material which seem to be floating around in

feedthrough. A similar stiff piece of wire on the other side of the chassis connects the feedthrough to piston capacitor C8. The rotor of C8 is fastened to a large ground lug which is soldered to the grid pin of the 4CX250B.

The folding of the two meter cavity reduces the total length of the neutralizing

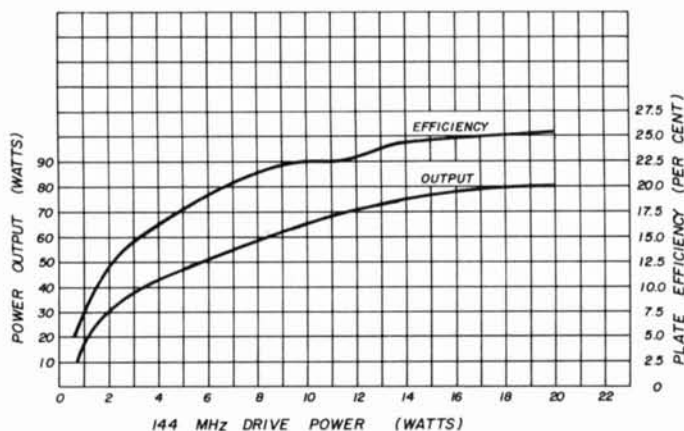

fig. 9. Operational characteristics of the amplifier when used as a tripler from 144 MHz to 432; B+, 1400 V; screen voltage, 270 V; grid bias -90 V.

some of the tubes occasionally lodge in a critical area. Each time a fuse blows, one of these pieces is vaporized.

I fuse the B+ with a 0.5 ampere 3AG fuse in a well insulated fuse holder connected in the negative side of the supply. The screen supply is fused with a 1/4-ampere 3AG fuse. The control-grid bias supply uses a current-limited regulator.

High voltage is brought into the chassis with RG-59/U cable and Amphenol MHV connectors. MHV connectors are rated to 5000 volts, and they automatically create a ground through the coax shield; RG-59/U cable is rated at 2300 volts rms. I strongly recommend using these or a similar type of high voltage connector for any final because groundless connectors represent a dangerous hazard if the ground system is disconnected.

neutralization

The two-meter neutralizing circuit consists of a 3/4-inch diameter brass plate held 1/2-inch below L2 in the vicinity of C2 by a stiff piece of wire soldered to a Teflon

circuit. This prevents the need for floating the grid circuit components, a technique which is required with the usual two meter neutralizing circuit. It is reassuring to perform the neutralizing procedure and observe the power fed through to the plate circuit disappear by approximately 30 dB.

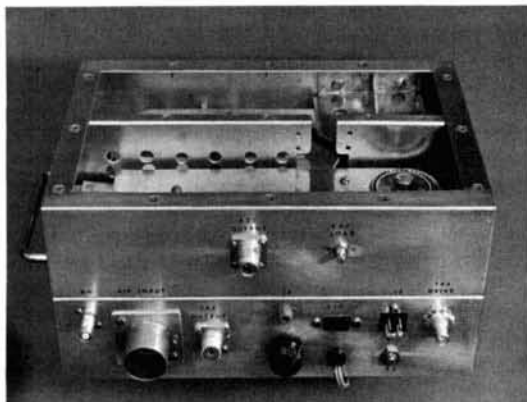

Rear view of unit shows high-voltage B+ MHV connector on lower left. The near cavity with the 4CX250B is tuned to 432 MHz; far cavity is tuned to 144 MHz.

Neutralization is carried out with filament and grid-bias voltage turned on and an appropriate amount of two-meter grid drive applied through an swr meter to J1. As you adjust C5 and C6 to 1:1 swr you will note a peak in grid current if your driver has a 50-ohm source impedance. If no swr meter is available merely adjust C5 and C6 for

tune up

The two-meter output circuit is adjusted with S1 and S2 in the 144 position and adjusting C2 and C4 for maximum indication on the output meter. L4 is adjusted for proper loading by bending it away from or nearer L2. When proper loading is obtained, C4 will be near its mid position, and

fig. 10. Test setup for the spectrum display of the 144-MHz output. Spectrum display is shown to the left. Center of display is 500 MHz, horizontal scale is 100 MHz/cm and vertical scale is 10 dB/cm.

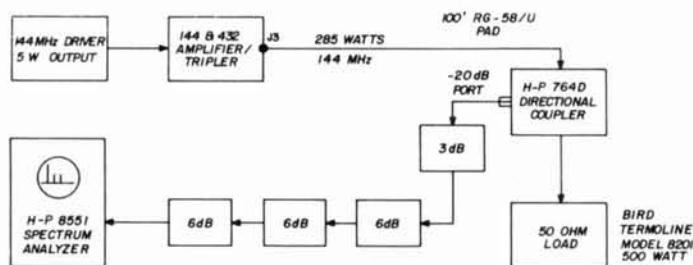

maximum final grid current.

Next, minimize C1. A grid-dip meter in the diode position and tuned to 144 MHz is held near the bend in the two-meter line, and C2 is adjusted for maximum indication. An insulated tuning tool is used to adjust C8 for minimum indication on the grid-dip meter. The amplifier is now neutralized. Slightly more accurate neutralization is obtained if the top cover is screwed down and the grid meter is coupled to a two turn link at J3. Very stable two-meter operation occurs with either neutralizing scheme.

screen current will be approximately 15 mA. Screen current should be monitored closely during tuneup since it's the best indication of tube loading; increasing screen current indicates decreased plate loading.

Screen current in excess of 40 mA for any appreciable time may destroy the screen grid. The plate, by comparison, is quite rugged when air is forced through it at greater than 10 cubic feet per minute. Air pressure at 0.5 inch of water is required to do this. A 4-inch squirrel-cage blower should be used.

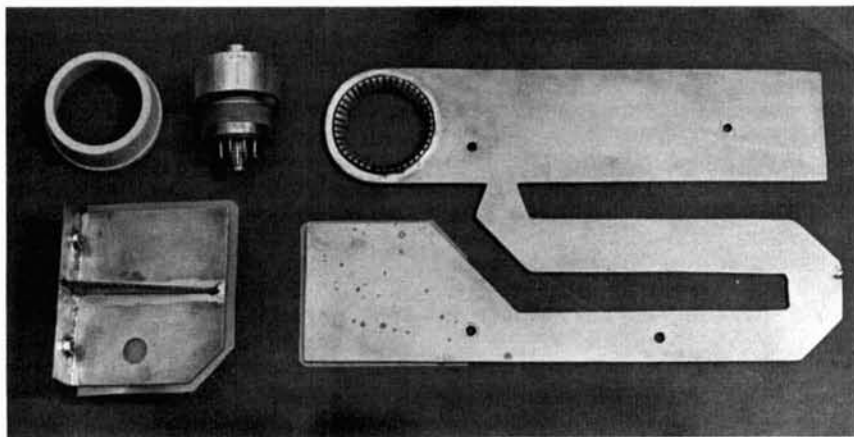

Resonant components are held in place with six screws. Stripline is to the right and fixed portion of C2 is on lower left; 4CX250B and air chimney are in upper left.

During 432-MHz tuneup 144-MHz grid drive is increased to 20 watts—if you have that much—switches S1 and S2 are set in the 432 position, C2 is minimized and a suitable load is connected to J2. When maximizing 432 output there is usually no clearly defined plate current dip; this is a normal characteristic of triplers, but the out-

put is 285 watts with 9 watts drive and a 1400-volt plate supply. Efficiency is a respectable 75 percent. Higher output could be obtained with a higher B+ supply. As a tripler to 432 MHz, the unit provides 80 watts output with 20 watts of two-meter drive; efficiency in this mode is about 25 percent.

One of the most important characteristics

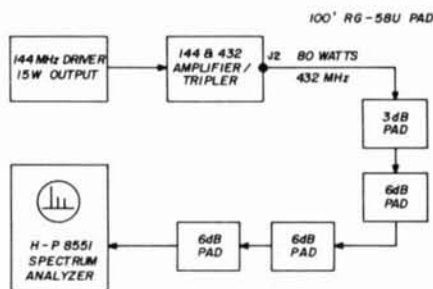
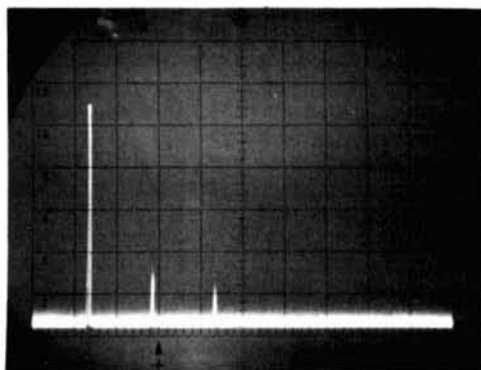
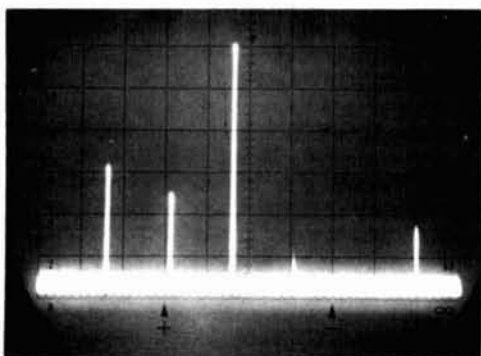

fig. 11. Test setup for the spectrum display of the unit operating as a tripler from 144 to 432 MHz. Spectrum display is to the right. Center of display is 480 MHz, horizontal scale is 100 MHz/cm and vertical scale is 10 dB/cm.



Spectrum analyzer display of 144-MHz output.



Spectrum analyzer display of 432-MHz output.

put metering circuit makes adjustment very easy. C1, C3, C5, C6 and R2 are varied while observing the output meter. I have found that lowering the screen or plate voltage is the best way to decrease output on 432. Decreasing the loading merely decreases the efficiency.

Schottky-barrier diodes with a recovery time of 100 picoseconds make a simple 432-MHz output metering circuit possible without a microammeter. Maximum rf voltage output always yields maximum power output regardless of the standing wave ratio of the antenna or the length of the transmission line (if no changes in the antenna or transmission line occur during the tune-up). The output-meter characteristics are shown in fig. 7.

performance

Complete performance characteristics of the 144/432 MHz amplifier/tripler are shown in figs. 8 and 9. On 144 MHz, power output

of vhf power amplifiers and frequency multipliers, and one of the least discussed, is the level of spurious outputs. Spectrum displays of this amplifier/tripler's output on 144 and 432 MHz are shown in figs. 10 and 11 along with the test setup used.

When operated as a power amplifier on 144 MHz, 288 MHz output was 41.5 dB down, 432 MHz output was 40.5 dB down and 576 MHz output was more than 50 dB down. With 285 watts output on two

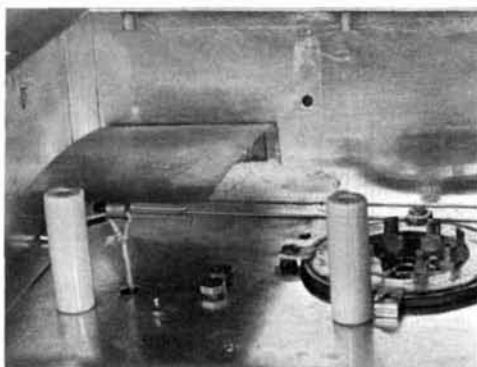

Closeup shot shows construction of C2.

meters, this represents 20 mW on 288 MHz, 25 mW on 432 MHz and less than 3 mW on 576 MHz.

As a tripler from 144 to 432 MHz, 144 MHz output is 34.0 dB down, 288 MHz output is 38.3 dB down, 576 MHz output is 50 dB down, 720 MHz output is 65 dB down and 864 MHz output is 43 dB down. With 70 watts output on 432 MHz, these figures correspond to 27.8 mW on 144, 10.4 mW on 288 MHz, 0.7 mW on 576 MHz, 0.02 mW on 720 MHz and 3.5 mW on 864 MHz. These figures have all been corrected for cable loss; in addition, the 144-MHz amplifier figures include measured directional coupler losses on each of the frequencies of interest.

summary

The techniques used in this dual-band final have other applications. With modifications of the grid and plate circuits, multiband operation on 144, 220 and 432 MHz should be possible. If a dual-band grid circuit similar to the present plate circuit is constructed, then this final will also have the option of operating straight through as an amplifier of 432 MHz. A multiband grid circuit doesn't need to be nearly as large as the plate circuit since much smaller power handling is required. The flapper capacitors could be replaced with commercial variable capacitors.

Most of the modern rf developments seem to be occurring in the solid-state field, but a person familiar with both vacuum tubes and transistors can select the best tech-

niques of each discipline. Although stripline was primarily a transistor-oriented development its advantages should give it considerable application with vacuum tubes. Stripline design graphs are available in "Reference Data for Radio Engineers."⁶

This amplifier/tripler would not have been possible without consultations with stripline authority Henry Keen, W2CTK.⁷ Thanks also go to James Buscemi, K2OVS, Edward Mentz, K2LCK, Richard Winderman, WA2OBG, Fred Telewski, WA2FSQ and Douglas McGarrett, WA2SAY for their valuable assistance.

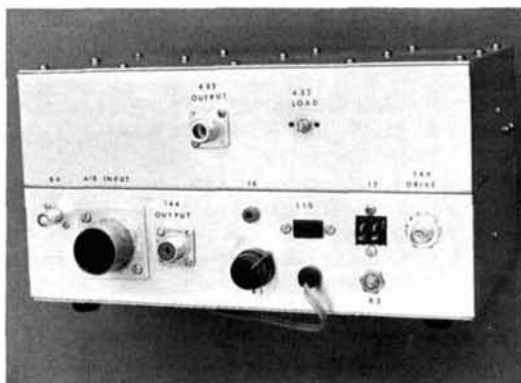

Rear view of the complete amplifier/tripler unit for 144 and 432 MHz.

references

1. William I. Orr, W6SAI, John T. Chambers, W6NLZ, "Stripline Kilowatt for 432 MHz," *ham radio*, September, 1968, p. 6.
2. Robert I. Sutherland, W6UOV, "Design Data for A Two-Kilowatt VHF Linear," *ham radio*, March, 1969, p. 6.
3. Frank C. Jones, W6AJF, "VHF for the Radio Amateur," Cowan Publishing Corporation, 1961, pp. 81, 82, 90, 97.
4. S. Cohn, "Characteristic Impedance of the Shielded-Strip Transmission Line," *IRE Transactions*, Vol. MTT-2, July, 1954, pp. 52-57.
5. Frank Davis, "Matching Network Designs with Computer Solutions," Motorola Application Note AN-267, 1967, Motorola Semiconductor Corporation, Phoenix, Arizona.
6. H. P. Westman, editor, *Reference Data for Radio Engineers*, 1956, ITT Corporation, New York, p. 598.
7. H. S. Keen, "Scientific Report on Study of Strip Transmission Lines," *Airborne Instruments Laboratory Report No. 2830-2*, December 1, 1955.

ham radio

INTRODUCING THE DELUXE **SWAN** *Cygnets*



MODEL 270 ... 5 BANDS ... 260 WATTS

The new Cygnets line is our latest development, and promises to become tremendously popular. Being self-contained with AC and DC power supply and loudspeaker, it is designed for easy portability, ideal for vacation or business trips, field day, or mobile operation. At the same time it provides all the necessary power and versatility for a complete home station. The 508 external VFO or 510X crystal oscillator will plug directly into the deluxe Cygnets 270, as will the VX-2 Vox unit or FP-1 Phone Patch. And, if you feel the need for more power, the Cygnets Linear provides a 5 times increase to better than 1200 watts. The Cygnets line comes with the same high quality and reliability that is traditional with all Swan products. And with the famous Swan customer service, if and when required.

S THE LITTLE GIANT DELUXE CYGNET TRANSCEIVER MODEL 270

260 watts P.E.P. input on 10 through 80 meters. A complete amateur radio station including 117 volt and 12 volt DC power supply and loudspeaker in one package with a handle. Has 100KC crystal calibrator, Dial Set, A.F. Gain, R.F. Gain, AGC, ALC, S-meter, sideband selection, all the features required for home station operation with enough power to work the world. Yet, the Cygnets is small and light enough for mobile or portable operation; an ideal traveling companion on business or vacation trips. **\$525**

S CYGNET MODEL 260

Standard version of Deluxe 270. Same power and circuitry, without some of the Deluxe features. Still a magnificent talking machine. **\$435**

S SWANTENNA MOBILE ANTENNAS

10, 15, 20, 40 and 75 meters. 500 watt power rating. High efficiency. No more coil changing.

MODEL 55 **\$95**
(Remote switching model)

MODEL 45 **65**
(Manual band selection)

S CYGNET LINEAR AMPLIFIER

1200 watts, P.E.P. input, 10 through 80 meters. Has self-contained AC power supply, and same cabinet size as Cygnets Transceivers. Utilizing a grounded grid, super cathode drive circuit with four 6LQ6's, both efficiency and linearity are exceptionally high. Plugs directly into Model 270. May be easily adapted to the 260 and other transceivers. **\$295**

OTHER ACCESSORIES:

S PLUG-IN VOX. FOR 270

Model VX-2 **\$35**

S PHONE PATCH

For all Swan Transceivers. Model FP-1 **\$48**

S CYGNET CARRYING CASE

Genuine leather, hand crafted in Mexico. With space for Mic., antenna and Log. **\$32**



SWAN

ELECTRONICS
OCEANSIDE, CALIFORNIA

A Subsidiary of Cubic Corporation

phase-modulated transmitter

for two meters

An interesting design
featuring solid-state
devices,
narrow bandwidth,
and low power
consumption

The transmitter shown here can be operated as a complete low-power vhf unit, or it can be used to drive a larger amplifier. The output at 144 MHz is between one-half and one watt when used with a 12-volt battery. As much as two watts can be obtained by running the buffer and final amplifier from a 26-volt supply, but this is getting toward the upper limit of the type 40280 transistor. The 40280 has a maximum rating of 7 watts input at 25°C, so under normal conditions, even with a good heat sink, about 4 watts input or less would be a safe limit.

transistor ratings

The buffer and last two doubler stages use a new, low-priced (55 cents) RCA type 2N5188 transistor rated at 4 watts maximum at 25°C. Probably two watts input would be a safe rating with a moderately good heat sink, and one watt input with only a clip-on collector and case cooler or radiator. Two different types of heat sink are used, as shown in the top chassis view. The black large-finned type is a little better for cooling than the small-ribbed aluminum coolers. The RCA 40280 output amplifier was slipped into a stud-mounting casing and the casing was mounted in a large-finned heat sink with mica washers for insulators. This permits operation at higher voltage and current, but it is not essential, as a 12-volt supply is used for all stages. A fairly good-sized finned cooler would be sufficient in this case if the input to the amplifier is kept to 1½ watts.

The 40280 transistor costs nearly five dollars as compared to fifty-five cents for the 2N5188, but is about 20 to 25 percent more efficient at 144 MHz and has a greater input power rating. If a half-watt output is sufficient, a 2N5188 can be used in the output stage at considerable savings in cost.

Some 2N5188 transistors are apparently

Frank C. Jones, W6AJF, 850 Donner Avenue, Sonoma, California 95476

nearly as good as the 40280. Probably their f_T is higher than average and approaches that of the 40280. In trying out a dozen 2N5288's, two were found that worked extremely well at 144 MHz, and three others were well above average in output. All functioned very well up to 72 MHz and not too badly at 144 MHz with a 12-volt supply. They have a maximum collector-to-emitter rating of 25 volts and a base-to-emitter rating of 5 volts. These values should never be exceeded, and a safe figure of $1/2$ of these values is advisable for dc ratings.

The 40280 has similar maximum ratings of 36 and 4 volts, so both types should operate from a 12- or 13-volt battery with long life expectancy. The 40280 has an f_T of 550 MHz vs 325 MHz for the 2N5188, which means less efficiency at vhf for the lower-priced transistor. Both are double diffused, epitaxial planer silicon transistors, with the same case and lead arrangements. The input and output capacitances are a little different, which means retuning circuits when interchanging these two types.

The 2N3553 is similar to the 40280 in cost and performance, but can be used at higher supply voltages, since its maximum rating is 65 volts. At 12 volts the results were about equal to the best 2N5188's.

amplifier stability

The amplifier circuit used with the 40280 was regenerative, so that care had to be taken to tune the input and output circuits correctly for maximum output at only the desired frequency. Using a dummy antenna, the rf output would sometimes double with the same rf drive, but with more than double the collector current. Monitoring the output with a receiver indicated faulty operation with lots of "hash" noise and less-than-normal carrier output at the desired frequency. This condition seemed to take place when the series output tuning capacitor was set at high values of capacitance. When kept below 15 pF, normal operation occurred with 100 to 150 mA at 12 volts.

the importance of high Q

Unless extremely high-Q tuned circuits are used, a single interstage circuit will

have more loss and less harmonic suppression than two circuits of moderate unloaded Q. These stages can then be loaded down to an operating Q of 10 or so, with good efficiency and good harmonic suppression. This approach was used in the transmitter illustrated here. Double-tuned circuits were used in all doubler and vhf stages.

frequency multiplier efficiency

Two types of frequency doublers were used, both having a low base-to-emitter impedance path for the doubler output frequency. Transistor doublers have considerable output-to-input feedback through the base-to-collector capacitance. This required a low impedance path from base to emitter to get much efficiency in the frequency multiplier.

The methods used here consisted of a low C-to-L ratio, series-tuned circuits from base to ground or emitter for the vhf range. A capacitance divider for matching the low base-input impedance to a higher LC impedance also provides a fairly low base-to-emitter impedance at the harmonic frequency as compared to the capacitance divider circuit.

Measurements indicated about twice as much output power available for the same rf drive when the base-to-emitter impedance is very low at the output harmonic frequency. No tests were made here in that regard for straight-through rf amplifiers. The capacitance divider coupling circuits for base input were used in the lower rf ranges.

Low-priced 2N2711 or 2N5182 bipolar transistors were used in the first three doubler stages. These have different pin connections, but are not too unlike for doubler service in this transmitter. Older type 2N706's can also be used, but these have a lower beta and are not quite as efficient as the newer types. In general, the higher-numbered transistors are more efficient and cost less (2N5182 is 40 cents new).

The circuit diagram (fig. 1) and photograph show plastic 2N2711's, since these were available from another project of a few years ago. The 2N706's were also tried in the last doubler and in the 144-MHz buf-

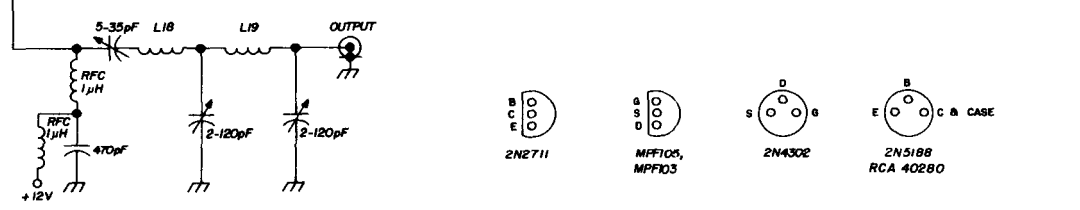
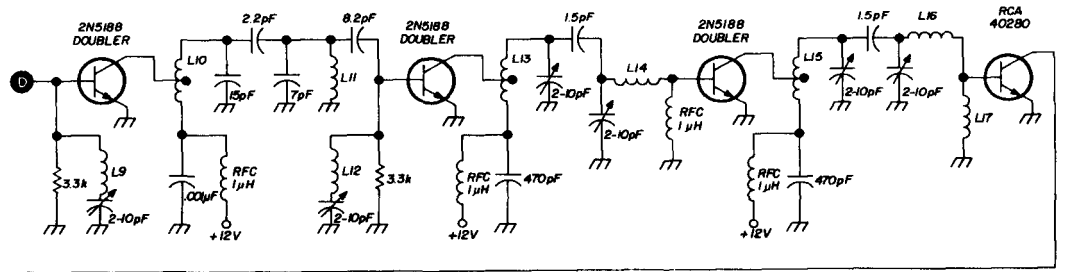
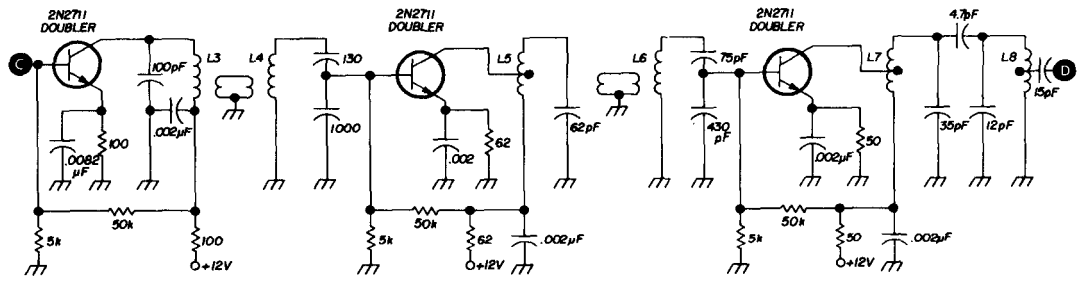
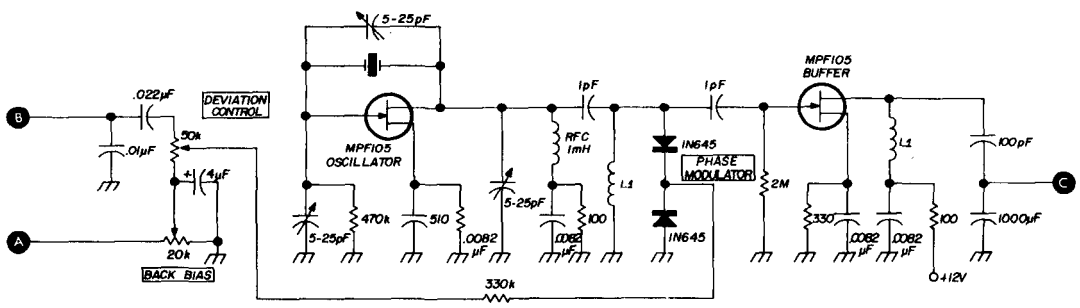
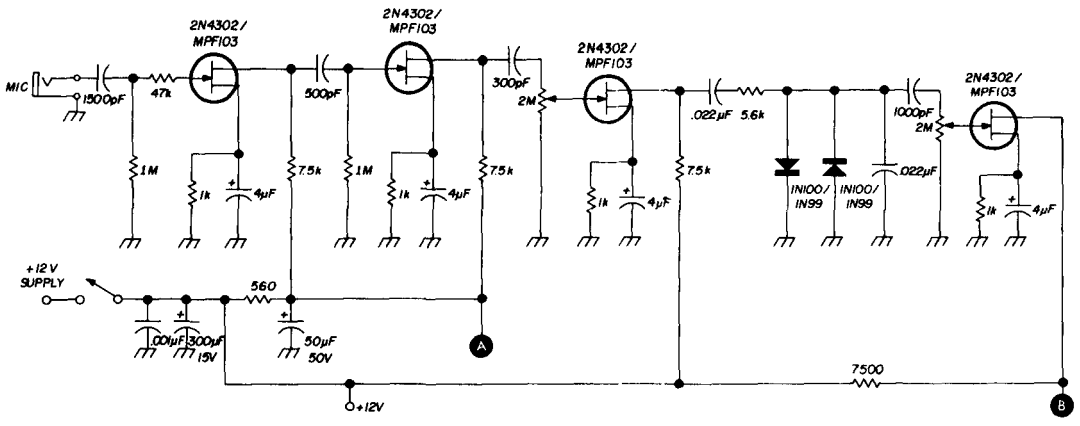

fig. 1. Schematic of the 144-MHz solid-state phase-modulated transmitter is shown to the left. Low-cost transistors and high-Q circuits are featured.

- L1 Broadcast band loopstick, 100 to 250 μ H.
- L2 40 turns no. 30E, 1/2 inch long x 1/2 inch diameter. F_r slug.
- L3, L4 22 turns no. 28E, 5/16 inch long x 1/2 inch diameter. F_r slug. 3 1/2 turn links.
- L5 17 turns no. 26E, 5/16 inch long x 1/4 inch diameter. Tap 10 turns up. 2 1/2-turn link.
- L6 Same as L5, except no tap. 2 1/2-turn link.
- L7 12 turns no. 26E, 1/4 inch long x 1/4 inch diameter. Brass slug. 6-turn tap.
- L8 Same as L7, except no tap.
- L9 21 turns no. 24C, 1/2 inch long x 1/4 inch diameter. No slug.
- L10 9 turns no. 22E, 1/4 inch long x 1/4 inch diameter. Brass slug. Tap 3 turns up.
- L11 Same as L10, except no tap.
- L12 10 turns no. 24C, 1/4 inch long x 1/4 inch diameter. No slug.
- L13 5 turns no. 18E, 1/2 inch long x 5/16 inch diameter. Tap 2 turns up.
- L14 8 turns no. 18E, 3/8 inch long x 1/4 inch diameter.
- L15 5 turns no. 18E, 1/2 inch long x 5/16 inch diameter. Tap 1 1/2 turns up.
- L16 5 turns no. 18E, 1/2 inch long x 1/4 inch diameter.
- L17 3 turns no. 18E, 3/16 inch long x 3/16 inch diameter.
- L18 6 turns 1/16-inch wide copper strip or no. 14E, 1 inch long x 5/16 inch diameter.
- L19 Same as L18, except 4 turns.

fer stages, but they got pretty hot and were less efficient than the 2N5188's. These stages were biased and driven to about 50 mA of collector current with a 12-volt supply. A dc voltmeter with an rf choke in one lead should be used to check the voltage on the doubler stages. The bias resistor in the base circuit should be low enough to keep operation well below the maximum rated base-to-emitter values listed in the transistor data sheets or handbooks. Too low a value will reduce rf output.

phase modulator

The phase modulator is rather interesting. It is a high-Q, very low-C circuit consisting

of a broadcast band "loopstick" slug-tuned coil with an inductance range of about 100 to 250 μ F. It is coupled lightly to the crystal oscillator and to the buffer input through 1-pF capacitors to keep the circuit at a high Q and low C.

Two small silicon (200 mA, 200 V) type 1N645 diodes were connected back-to-back, with some reverse dc bias, to act as small variable capacitors across the loopstick coil. The resting dc bias, of some value between 6 and 12 volts, sets the initial capacitance of these "variable capacitor diodes." The voltage from the audio amplifier then varies the capacitance and the phase of this circuit.

The coil slug is adjusted to bring the circuit near the crystal frequency, since the LC phase changes rapidly and fairly linearly in this region. The variable-capacitor diodes, back-biased, have a resistance of probably 1000 megohms; thus they have practically no effect on the circuit Q. A reactance-type transistor would load the circuit. The diodes are connected back-to-back to reduce the possibility of the peak rf voltage biasing the diodes in the forward direction.

Very small capacitance coupling to the oscillator is needed to keep the rf peak voltage to a few volts across this high-Q circuit. The higher the Q, the less capacitance change needed for a given amount of phase modulation.

modulator diode considerations

A low-Q circuit in the modulator usually requires special varicap diodes, which are more costly than small silicon power-rectifier diodes. Computer diodes generally have too small a capacitance change to work well in this circuit. "Top hat" rectifier diodes also work, but often have a larger shunt capacitance, so the small glass-enclosed diodes are better. Pick a couple that show "infinite" back resistance on an ohmmeter test, and be certain that the cathodes are connected together and to the af and plus dc bias circuit. The power rectifier diodes have much less capacity change than a regular varicap, but work in exactly the same manner.

The af amplifier uses some surplus fet's in a resistance-coupled system. Motorola MPF103's are reasonably priced and may be used in place of the 2N4302 transistors shown in **fig. 1**. The socket connections are different, however.

A simple diode speech clipper was used to run the phase modulation at a fairly high average level. This requires an additional af stage and gain control to function well.

construction notes

At this point it should be apparent that this article is more concerned with ideas for good transistor circuit design than with a pure mechanical layout or design that can be copied exactly. As the photographs show, there are extra holes in the 5x13-inch copper-plated panel that resulted from numerous experiments in the design. This panel, copper side down, was mounted in an old 5x13x3-inch chassis for shielding and protection of parts. Coil data is given in **fig. 1**.

After some difficulties were ironed out in the crystal oscillator, this transmitter was used to transmit fm signals through a MARS repeater station. The main problem here was to get onto the exact frequency and stay there. One of the npo variable ceramic capacitors in the crystal oscillator either was not really an npo unit or had a faulty bearing. Once the correct values were obtained, the ceramic variables were replaced with fixed silver mica capacitors except for the one across the crystal (this was changed to an air-type variable padder so the crystal could be set to oscillate within a few Hz of the value desired). A 22 pF capacitor from gate to ground and a 5 pF or 10 pF from drain to ground were suitable values. A 5- to 25-pF variable was placed across the crystal. Motorola MPF105 fet's were used in the crystal oscillator and in the buffer stage at $4.6 \pm$ MHz.

operation and tuning

The five doubler stages multiply the crystal frequency 32 times and increase the phase modulation. The final result is a phase-modulated signal in the two-meter band with a bandwidth of 5 kHz or more,

suitable for voice communication with a narrow-band fm receiver.

The total current drain with a 12-volt dry battery, storage battery, or regulated power supply is about 1/3 ampere. If the current is near 0.5 A, probably a parasitic oscillation is present in the 40280 transistor stage.

In tuning up the transmitter, the total current drain will be about 10 or 20 mA with the crystal out. Each stage, as it is tuned to resonance (with the crystal oscillator working), will increase the total dc current a few mA until the power transistor stages are reached. All these stages, using bipolar transistors, run at near-zero current until rf drive is applied to each stage. If any rf or doubler stages in this system draw appreciable current with the crystal out, then parasitic oscillation, incorrect wiring, or faulty transistors can be suspected.

After some rf output is obtained, the series-trap circuits at 72 and 144 MHz can be peaked for maximum output. Some tuning adjustments on these circuits can actually reduce the stage output to a very low value. The correct adjustment results in maximum rf output.

A radio receiver is used to monitor the output on two meters during tuneup. Use a 50-ohm, 1-watt dummy antenna and rf voltmeter (or a dummy antenna and swr meter). Again monitor the output on two meters after an antenna is connected, since an antenna usually presents a different load than a dummy antenna. This may cause the output amplifier to self-oscillate until proper loading is again set in the output pi coupling circuits. Physical layout, ground connections, bypass capacitor reactances and rf chokes can all cause variations in the operation of an unneutralized rf amplifier.

Phase or frequency modulation permits more leeway than if the transmitter were amplitude modulated. Personally, it seems to me that a transistor linear amplifier would be easier to tame than an amplitude-modulated amplifier. Even in a cw or phase-modulated transmitter, parasitic or self oscillation is definitely not to be permitted on the air.

ham radio



The **HAMMARLUND** Manufacturing Company Incorporated

20 BRIDGE AVE., RED BANK, N. J. 07701. CABLE: EACORP-REDBANK, N. J. TEL. 201-842-5700 A SUBSIDIARY OF ELECTRONIC ASSISTANCE CORPORATION

1970

Dear O.M.:

Every month we put our best foot forward and try our darndest to convince you to buy our product. I try to make our ads convincing in the hope you will rush to your favorite distributor to buy a Hammarlund product.

You have seen Hammarlund ads these many months. We are still building the radios you saw advertised on these pages during 1969. I honestly feel if you haven't used a Hammarlund receiver or linear in 1969, you owe it to yourself to try one. I'll bet you know at least one ham buddy who has a Hammarlund radio in his shack. And I know he'll be proud to show it off!

Tell you what I'm gonna' do - if you take the time to make this "Instant Demo" and you believe as your friend and I do - and buy a new Hammarlund radio, I'll send both of you a Hammarlund accessory of your choice - speaker, clock or crystal calibrator.

I'll keep this offer alive for February and March to give you all a chance to really try it for yourself.

Drop me a note or stop in to see your distributor for more information. A list of Hammarlund distributors is available; upon your request, I'll send you the names of your local Hammarlund Authorized Distributor.

73.
Irving Strauber
Irving Strauber
W2ERV/W4MVC

20 Bridge Avenue
Red Bank, N. J. 07701

SO YOU WANT
CRYSTALS
FASTER!



24

HOUR DELIVERY ON
ALL ORDERS OF TEN
CRYSTALS OR LESS

...well it will take someone
with manufacturing
"know how" to do it

But of more importance the crystal must be manufactured to Strict Specifications, have good activity and operate "on frequency" in the circuit for which it was ordered.

SENTRY can manufacture crystals for all two-way radio equipment: Commercial, Amateur, Aircraft, Military and Citizen Band. You need only to specify the model of set and channel frequency.

You don't believe it, when we say - "Buy the Best"?

You are satisfied with your present supplier?

You are satisfied with high prices?

You are satisfied with "second best"?

Until you try SENTRY you will never know!

Try Us! Make Us Prove It! "Buy the Best"

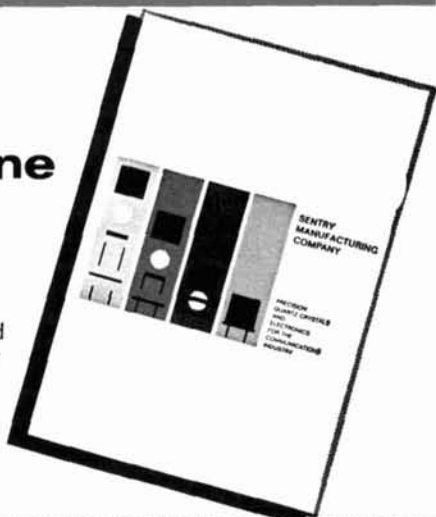

SEND FOR OUR CATALOG OF PRECISION
QUARTZ CRYSTALS AND ELECTRONICS
FOR THE COMMUNICATIONS INDUSTRY.
IT WILL COST YOU NOTHING!



SENTRY MANUFACTURING COMPANY

Crystal Park, Chickasha, Oklahoma 73018

PHONE: 405-224-6780

a survey of solid-state power supplies

Regulated power
is a must
for today's
new circuits—
here's a report
on some new devices
and
their applications

Hank Olson, W6GXN, P.O. Box 339, Menlo Park, California 94025

Since the publication of a previous article on power-supply design¹, the semiconductor industry has introduced devices that have made a tremendous impact on the world of power supplies. Therefore, a review of power supply theory, with a transition to these new semiconductor devices, is in order.

basic circuit

The rectifier-filter section of the power supply is ordinarily one of the five familiar types shown in **fig. 1**. Of these, I don't generally use any but the full wave, bridge or conventional doubler. I favor these because they have much better regulation and ripple reduction. Ripple reduction is better because the ripple frequency is twice that of the line frequency. Compared to a half-wave circuit, the chokes and capacitors in a full-wave rectifier effectively have twice the inductive reactance and one-half the capacitive reactance respectively.

Another convincing argument in favor of the full-wave and bridge circuits is that either choke input or capacitive input may be used. Thus, for any given transformer, two dc output voltages are available in the bridge connection, and two more are available in the full-wave circuit.

I use the half-wave types (half-wave and cascade doubler, **fig. 1**) only when it's necessary to ground one side of the transformer secondary. Such a requirement usually occurs when adding on to existing equipment.

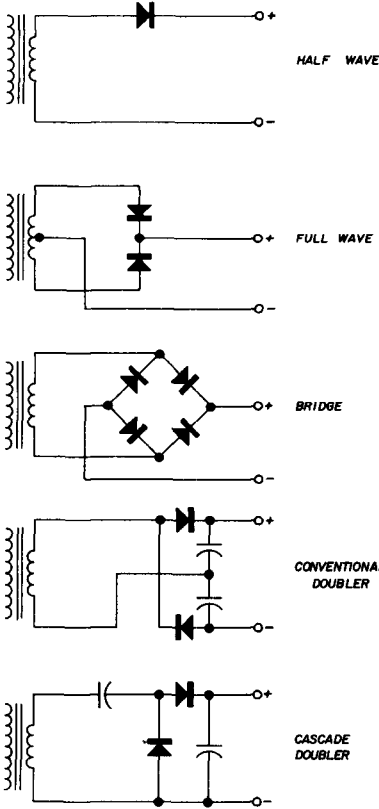

fig. 1. Commonly used rectifier circuits. Full-wave versions provide best regulation and ripple attenuation.

series voltage regulators

The simplest voltage regulator that uses gain is the emitter-follower type, **fig. 2**. The transistor current gain, h_{fe} , allows this series regulator to regulate much more current than the zener by itself. Another important advantage is that the circuit also functions as a capacitance multiplier. The base voltage is filtered by R1-C1 in addition to any filtering ahead of the regulator. Since it is an emitter-follower, the emitter "follows" the base, so

the output is as well filtered as the base.

Where did the ripple go? It's soaked up by the collector-to-base potential, which varies at the ripple-frequency rate. Note that enough voltage must be across the collector-base junction so that negative swings of the ripple voltage don't go below the zener-regulated base voltage.

transistor current gain

The transistor current gain is important in this type of regulator as well as in the others to be discussed. The higher the current gain, the less base current necessary for any given regulated output current. The higher h_{fe} is, the larger R1 can be. This results in better RC filtering (by capacitance multiplication). **Fig. 3** illustrates this with three similar emitter-follower regulators, their respective peak-to-peak ripple output, and output voltage as a function of current. All have the same rectifier-filter sections and load resistances.

the darlington pair

Fig. 3C uses a trick called the Darlington pair: two transistors are connected as one to obtain the product of their current gains as the combined h_{fe} . This may seem unfair while we're making comparisons, but **this** Darlington pair is in one package and is used just like any other transistor. Of course, separate transistors can also be used similarly but the common-chip types have a thermal-tracking advantage. Note that there are two emitter-base diode voltage drops between the zener and the output, so a higher-voltage zener must be used.

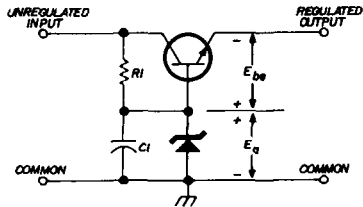
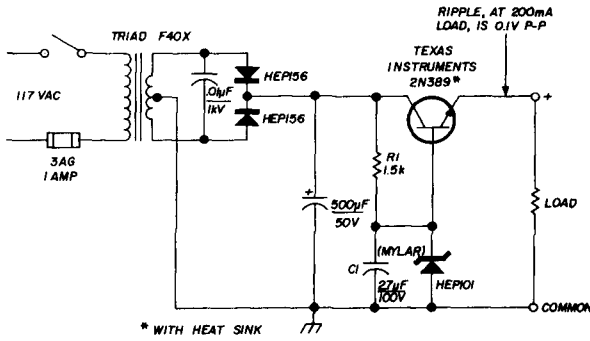
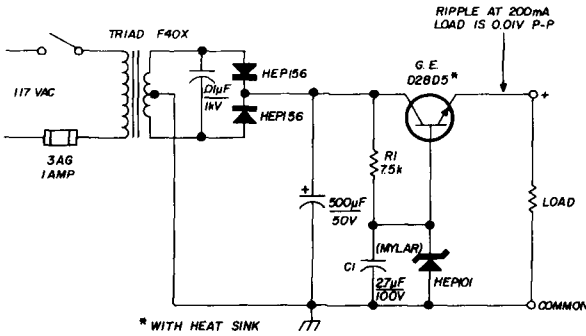

fig. 2. Emitter-follower series regulator. Transistor current gain gives more current regulation than the zener alone.



A



B

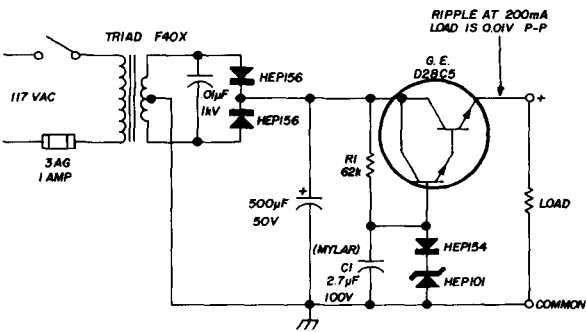

C

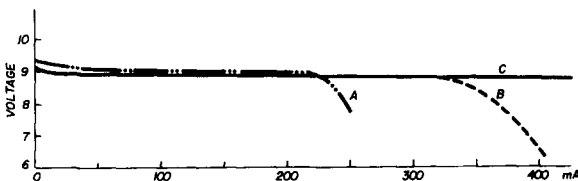

fig. 3. Series regulators with "capacitance multiplication." The Darlington Pair is shown in C; higher zener impedance causes ripple voltage to be the same as in B.

It's also possible to use another form of two-transistor combination in the emitter-follower regulator. Fig. 5 shows such an arrangement; note that complementary transistors are used. Unfortunately, no single-package npn-pnp transistor is yet available for this circuit, so separate transistors were used. The advantage of this "compound emitter follower" over the Darlington Pair is that it has only **one** base-emitter diode voltage drop between control base and output.

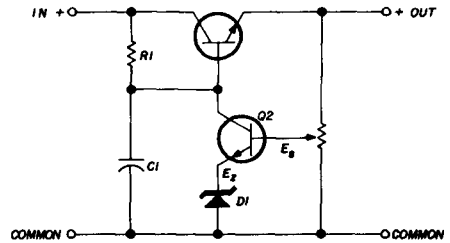

fig. 4. Reference amplifier regulator, allowing adjustable output voltage. R1 is collector load resistance for Q2, a dc amplifier.

adjustable output voltage

The emitter-follower regulator, with its simplicity, is a useful regulating circuit, but it has a troublesome characteristic. The output voltage is fixed at $E_z - E_{be}$ (the zener breakdown voltage less the transistor base-to-emitter diode forward voltage drop).

By making the circuit a bit more complex, output voltage can be made adjustable. Fig. 4 shows the more sophisticated circuit. Now, R becomes a collector load resistance for Q₂, a dc amplifier. Q₂ amplifies the difference between E_z , the zener voltage and E_{be} , a fixed fraction of the regulated output voltage (error voltage). This form of voltage regulator is widely used because it is simple and adjustable. Because of this wide use, several companies have offered integrated packages containing Q₂ and D₁.³ An actual circuit is shown in fig. 6A for a "handle on reality." Note that in such circuits C₁ is not made large for capacitance multiplication, but the added gain of the circuit is relied upon for ripple attenuation.

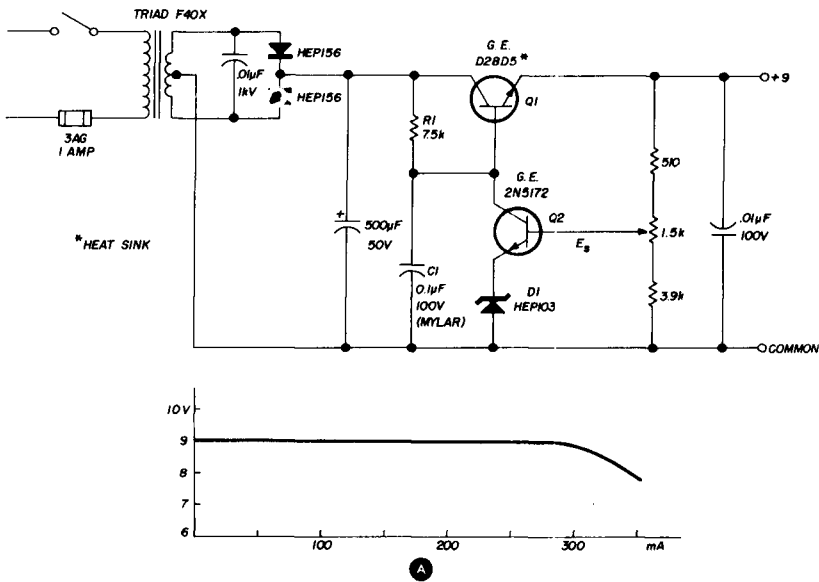

fig. 6. Practical circuits using reference amplifier principle. The new G.E. "programmable zener," a small-scale

the programmable zener regulator

An interesting new device from General Electric is a monolithically constructed regulator called a "programmable zener." It doesn't have a number assigned as yet, but if it's like other members of G.E.'s small-scale integrated circuit line, it'll probably have a D13XX number with a price tag of about a dollar. A circuit using it, **fig. 6B**, is similar to that of **fig. 6A**. Note its new circuit symbol. (I assume that the zener in this IC is an emitter-base breakdown diode.) The circuit using the programmable zener regulator shows good regulation to well over one-half ampere of load current.

differential dc amplifier regulator

By adding one or more transistors to our regulator, even better regulation can be obtained. **Fig. 7** shows how a differential dc amplifier allows the zener reference to run at a constant low current, improving reference stability.

The improvement offered by this differential amplifier is especially noticeable if its main function is to compensate for variations in the input voltage. A typical case would be where the input is from a 12-volt line in an auto electrical system. **Fig. 8** shows a practical

regulated supply using the differential amplifier. The differential amplifier IC is one of the most practical monolithic circuits.

fet regulator

Still another interesting development on the power supply scene is the use of power

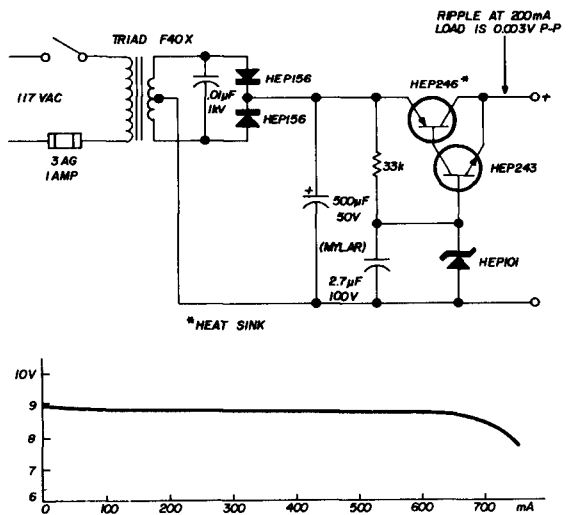
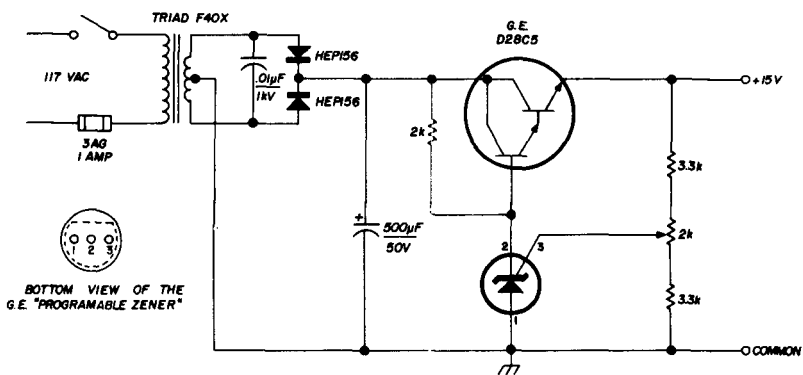
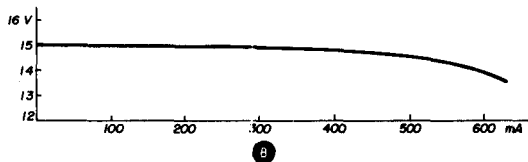

fig. 5. The "compound emitter-follower" regulator. Compared to the Darlington Pair, it has only one base-emitter voltage diode drop between base and output.



BOTTOM VIEW OF THE G.E. "PROGRAMABLE ZENER"



IC, is shown in B.

fet's as series regulators.⁴ This has only recently become economically feasible, because several semiconductor manufacturers are now making power fet's, and the prices are beginning to come down.

There are several advantages to using a fet as a series regulator. The first is that the regulator has inherent current limiting, since the fet current is limited to I_{dss} . The second advantage is that "thermal runaway," as experienced with bipolar transistors, is not possible. The third reason is that because of the high impedance of the gate, essentially no gate current is required to control the fet current. This makes the fet gate even easier

for the dc amplifier to control, and higher dc gain may be used.

The circuit shown in **fig. 9** uses a series power fet, a bipolar dc amplifier, and a second fet as a constant-current source. The constant-current source replaces the usual resistor load of the dc amplifier. By using the constant-current source as a load resistor, higher voltage gain can be obtained in the dc amplifier. The 5k adjustable source resistor allows the constant-current flow to be set to the value giving best temperature stability. This is usually around 0.33 mA. Because rather low current is used in the dc amplifier, a bipolar transistor displaying

fig. 7. Differential dc amplifier regulator. Zener reference runs at constant low current, improving reference stability.

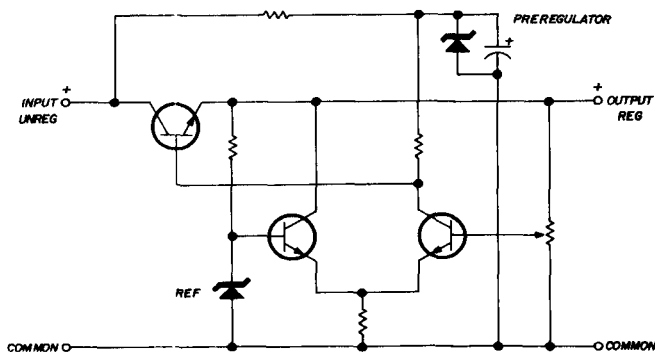

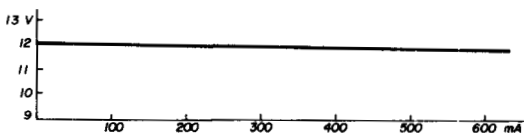
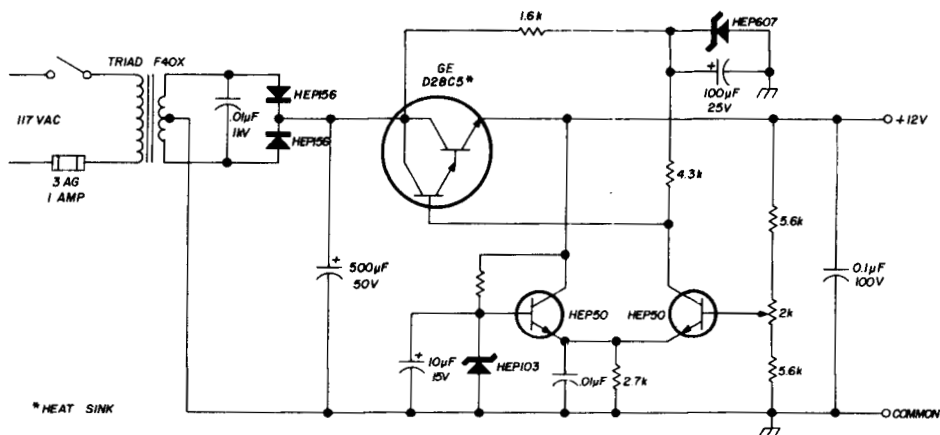

fig. 8. Practical application of the dc differential amplifier.

good h_{fe} at low current (the Fairchild 2N3565) was used. Also, the zener was chosen to have a low impedance at 0.33 mA.

Since the supply of fig. 9 uses choke input,

a minimum load is required, which is supplied by the number 327 pilot lamp.

There are a couple of disadvantages to using an fet series regulator, but these are

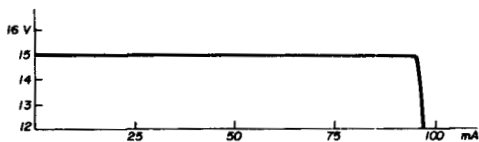
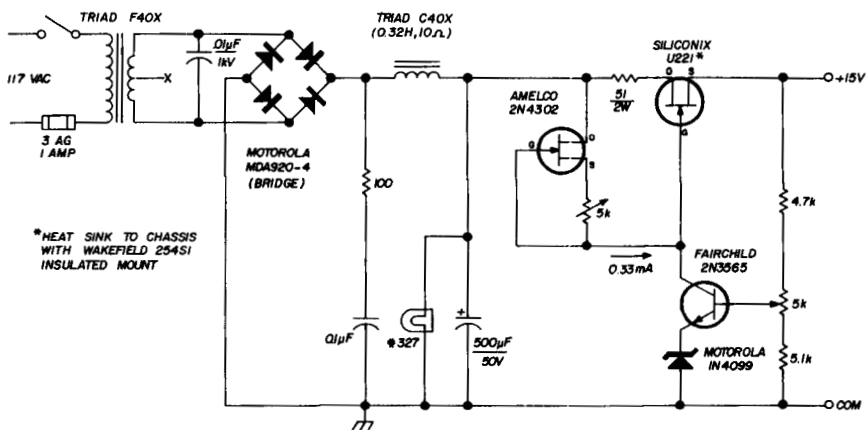

fig. 9. Series-regulated supply using power fet's. The second fet replaces the usual resistor load as a constant-current source allowing higher voltage gain.

not intrinsic faults. The obvious problem is cost; the less obvious one is loose specification of I_{dss} . The Siliconix U221 and U222 have I_{dss} specifications of about 2 to 1, which are considerably tighter than those of the competition power fet's. As power fet technology advances, we can certainly ex-

ing semiconductors; zeners replace VR tubes, and an enhancement-mode fet replaces the zero-bias triode. Such a direct equivalent circuit is shown in **fig. 11**. It would probably not be built today, because n-channel enhancement-mode fet's are not yet commonly available.

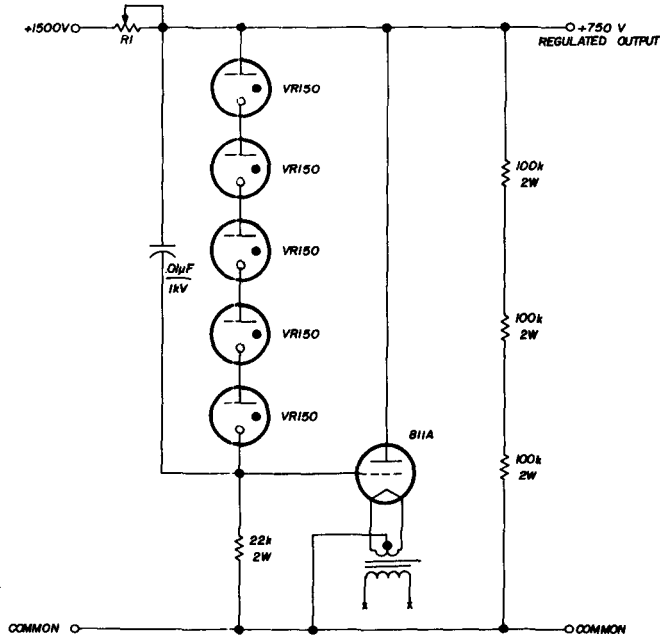

fig. 10. Typical tube-type regulator. The 811A bias, controlled by the VR tubes, changes the voltage across R1 thus regulating the output voltage.

pect to see prices drop and perhaps more predictable I_{dss} from any given off-shelf device.

the shunt regulator

Before discussing the replacement of the discrete differential amplifier with an IC, there's one more circuit we should look at: the shunt regulator. The vacuum-tube shunt regulator has been in use by hams for many years. **Fig. 10** shows a typical HV type.⁵ The operation is as follows:

If the +750 V output drops, the drop is directly coupled to the grid of the 811A by the VR tubes, dropping the bias. This causes the 811A to draw less current, thereby decreasing the voltage drop across R1, and raising the +750 V output.

A similar shunt regulator can be made us-

A more conventional approach to the shunt regulator is that of **fig. 12**, using a bipolar transistor. An actual circuit is shown in **fig. 13**. Another more complex shunt regulator is shown in **fig. 14**, using a differential amplifier. Note that both of these circuits

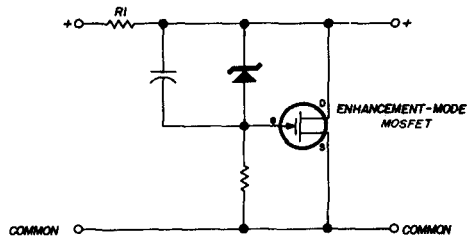

fig. 11. Semiconductor equivalent of the vacuum-tube regulator. (N-channel enhancement-mode fet's are not yet commonly available.)

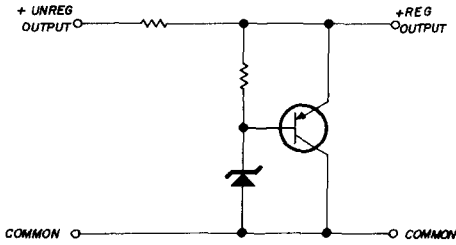

fig. 12. Shunt regulator using bipolar transistor.

(figs. 13 and 14) have a convenient feature: the collector (case on most power transistors) is grounded.

The shunt regulator is often overlooked because of its inefficiency when unloaded. However, in many systems the load is nearly constant, and the shunt regulator is used mainly to provide a low power supply source impedance. The regulator in fig. 14 was designed to power a system consisting of about a dozen DTL integrated circuits, which had a nearly constant drain. Note also that the shunt regulator is ideal for the choke-input rectifier filter, because it provides a constant load.

ic's as voltage regulators

We have seen two beginning steps toward integration of circuits. These are the "ref amp" and the "Darlington pair" as represented by General Electric's RA1 and D28C5. Each of these units contains two semiconductor devices. Modern IC technology has

expanded greatly on the number of devices per package. It's now usual for IC's to have dozens, or even hundreds, of devices on one chip.

Among these complex IC's are a few designed specifically for voltage regulators. National Semiconductor makes the LM300, LM304 and LM305 voltage regulators; Fairchild makes the μ A723 regulator; Motorola makes the MC1460G and MC1460R; and the Continental Devices Corporation makes the CMC513-4. Other companies^{6,7} produce IC voltage regulators, but their prices are more than \$10.00 and therefore aren't within the amateur price bracket in my opinion.

The LM300 was perhaps the first to hit the market and has been described in a previous article.⁸ Its use in a +15 V supply is shown in fig. 15.

Since the original LM300 was first marketed, National Semiconductor has added the LM304 and the LM305. The LM305 is simply an improved LM300 (at a somewhat higher price); it can be plugged into the circuit of fig. 15 to provide improved regulation. The LM304 is a **negative** voltage regulator; its use in a -15 V supply is shown in fig. 16.

Fairchild has entered the integrated regulator field with the μ A723. The μ A723 may be used either as a positive or negative regulator as shown in figs. 17 and 18. The many uses of the μ A723 are covered in detail in reference 9.

The least expensive IC regulator covered

fig. 13. Practical shunt regulator supply using the bipolar transistor.

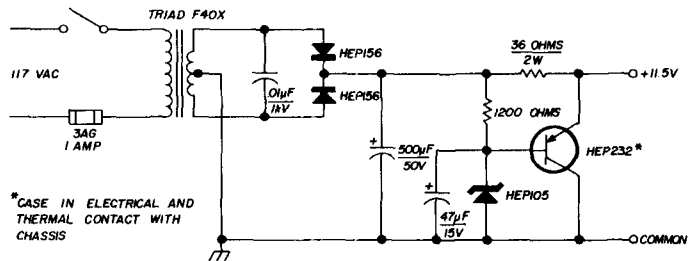

*CASE IN ELECTRICAL AND THERMAL CONTACT WITH CHASSIS

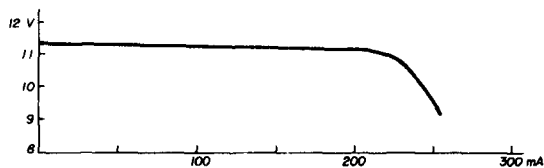

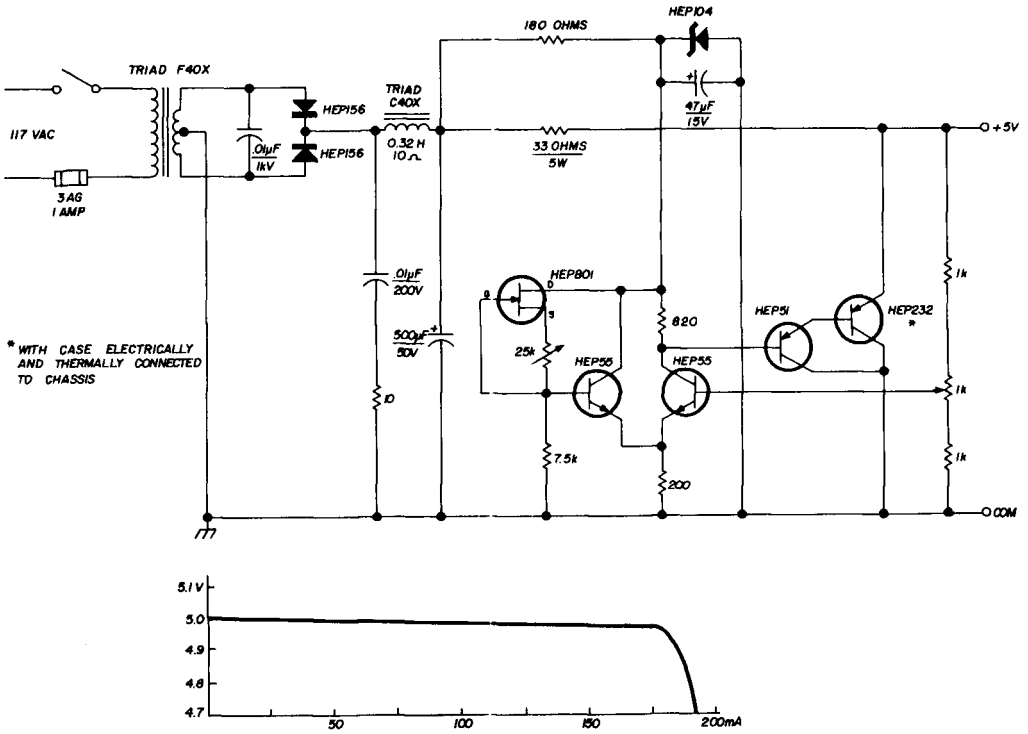

fig. 14. Shunt regulator using a differential amplifier circuit. This was used to power a dozen IC's.

here is a member of a family of five 15 volt regulators, each with the prefix CMC514. The CMC514-4 is the least sophisticated; it is also the only one in the ceramic-epoxy TO5 package (and therefore the least expensive). The CMC514-4 has only three leads, so it looks for all the world like a 2N3638—it isn't! Fig. 19 shows it in a simple regulated sup-

ply; note that it has only an input, an output, and a ground lead. The CMC514-4 has a built-in thermistor, fig. 20. If too much current is drawn, the chip overheats and the thermistor turns the regulator off! When chip temperature drops, the regulator begins regulating again.

A late entry into the regulator IC field is

fig. 15. A regulated +15 V supply using an LM300 IC.

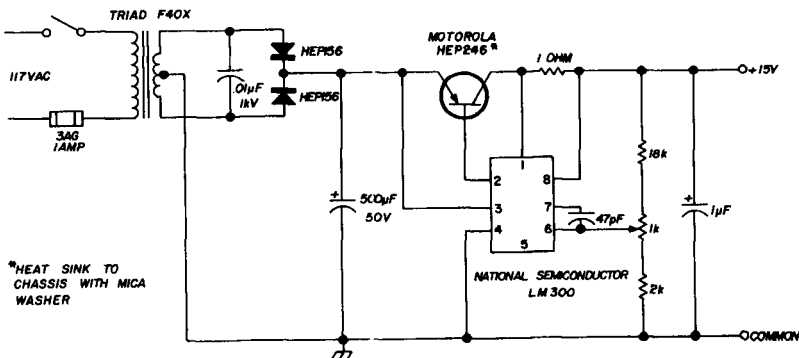

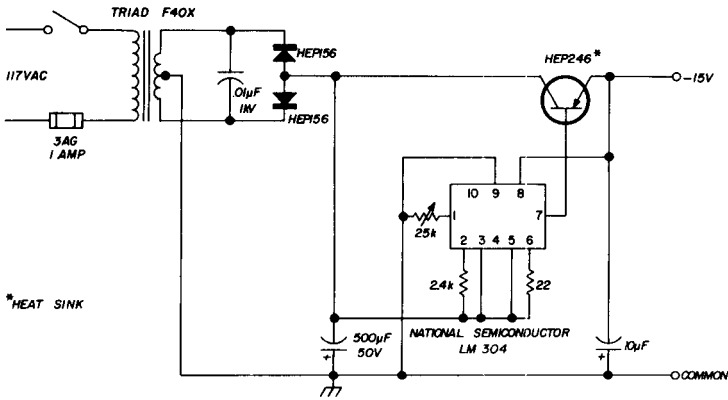

fig. 16. A -15 V supply. This IC is a negative voltage regulator.

the Motorola MC1460. It comes in a ten-lead TO-5 package (the MC 1460G) at \$5.25 and in a small-diamond package (the MC1460R)

at \$6.75. The R model will, of course, handle more current, because it's easier to heat sink. In fig. 21, an MC1460G is used in a +15 V

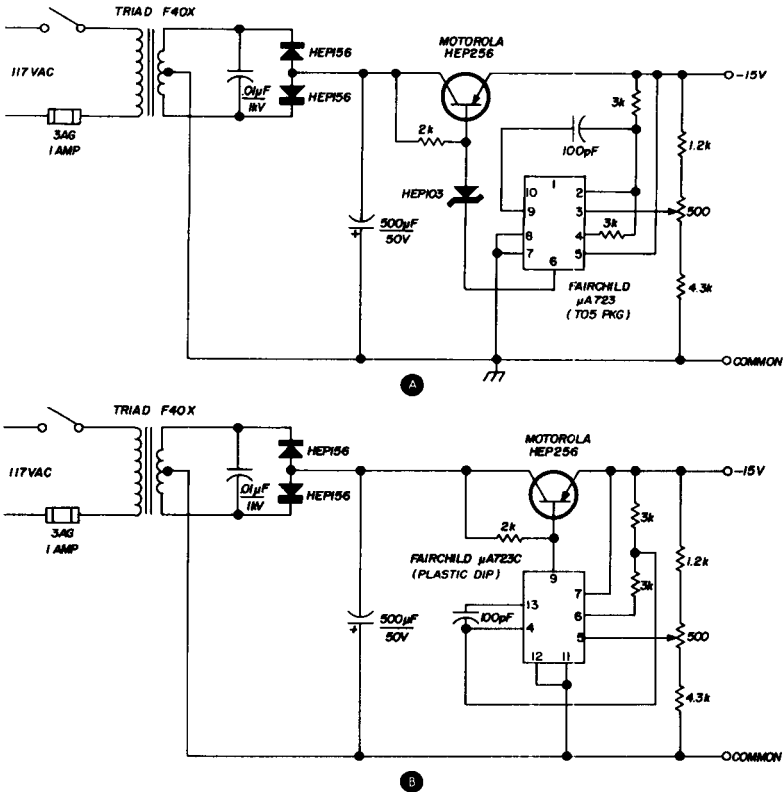

fig. 17. Another application of an IC in a regulated supply. Note that no external zener is needed in B.

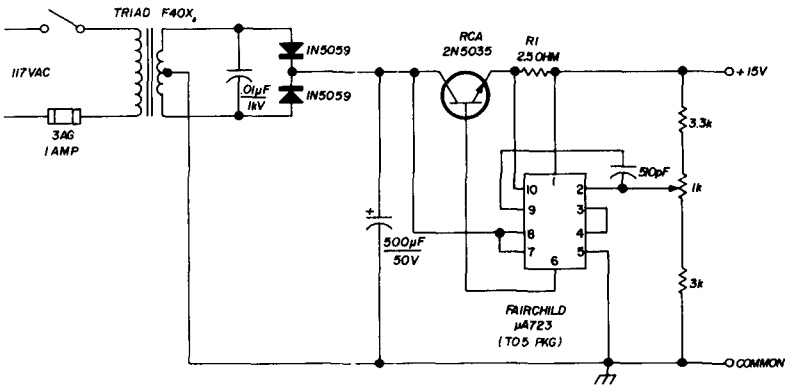

fig. 18. This IC may be used either as a positive or negative voltage regulator; here it's shown in a +15 V regulated power supply. R1 determines current limiting. The value shown in for 200 mA.

regulated supply. Details on how to use this IC are given in reference 10.

The MC1460 has a shut-down port (pin 2). In fig. 21, pin 2 is grounded, and so does nothing, but it can be used to turn off the

This opens a myriad of possibilities: squelch control of the regulator to conserve power in the output stages of a receiver, shut-down upon demand by a temperature sensor, and so on.

fig. 19. A +15 V regulated supply using the least-expensive IC. It comes in a ceramic-epoxy TO5 package.

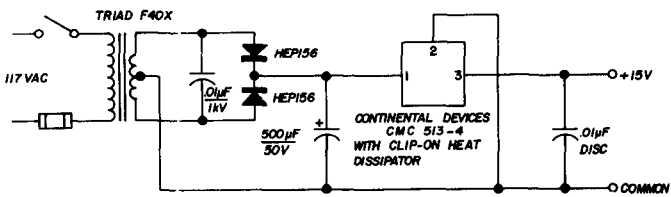

regulator. If pin 2 is made high by a few volts, the regulator shuts down. This high state is low enough so that RTL, DTL or TTL logic levels can be easily used for control.

The MC1460 also has a built-in provision for current limiting. The 2.7-ohm resistor in fig. 21 determines at what current the supply will limit. By making this resistor smaller,

fig. 20. Internal circuit of the CMC 514-4 showing internal thermistor.

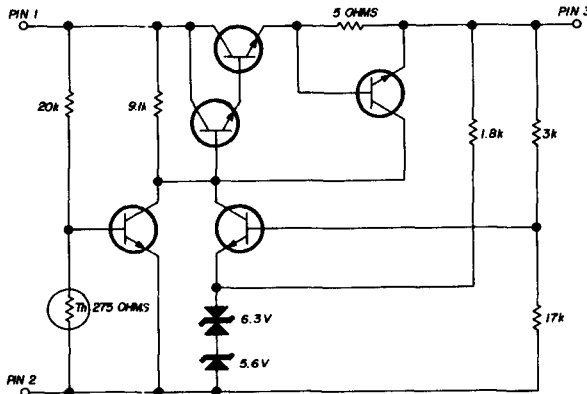

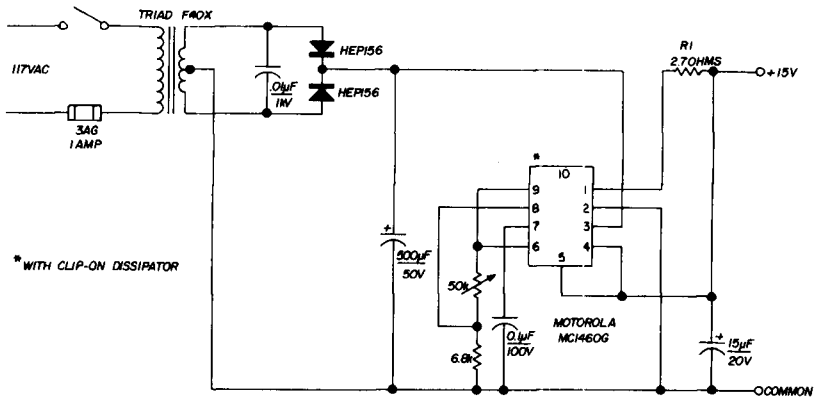

fig. 21. Motorola's MC1460G IC regulator in a +15 V supply has a current-limiting resistor (R1).

the regulator will limit at a larger current. A smaller resistor would probably not be used with the MC1406G, but could be used with the MC1460R.

other ic's as regulators

We've seen how a number of special IC's can be used (for their intended purpose) as regulators. It's also possible to use others, not sold as regulators, for similar applications. Of course, nearly any operational am-

plifier can be used as the differential comparator in a regulator, providing that a reference, a series-pass transistor, and a fair number of other external parts are used. This makes a good regulator, but the complexity defeats one of the main reasons for using an IC—simplicity. Reference 11 shows how this is implemented using a μ A709.

Two inexpensive audio amplifiers can be used as regulators. The General Electric PA234 and PA237 are 1- and 2-watt af output

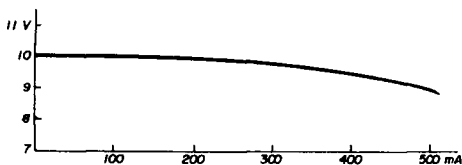
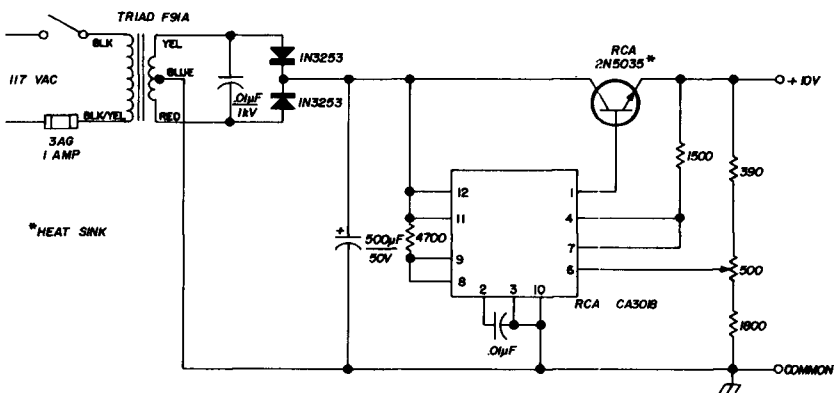

fig. 22. Another inexpensive IC in a voltage regulator circuit. An emitter-base diode in reverse breakdown provides the reference; an external series pass transistor must be added.

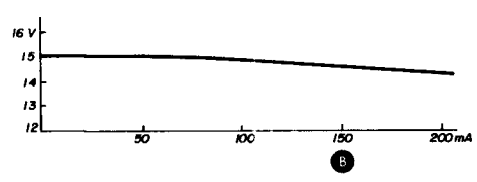
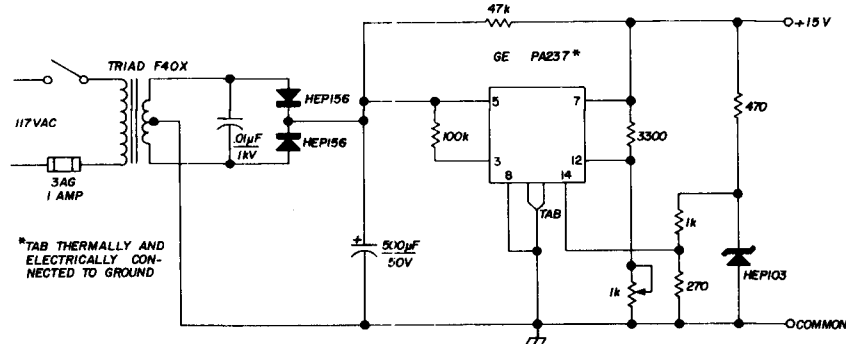
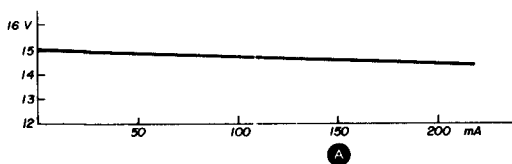
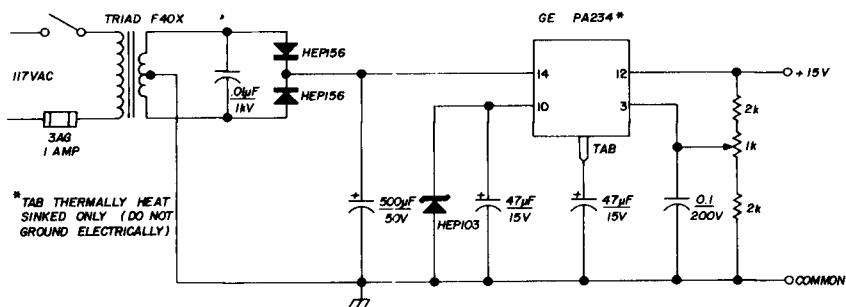

fig. 23. Two inexpensive af amplifier IC's used as regulators in a +15 V supply. Current limitation is determined by package dissipation (0.8 W at 25° C).

amplifiers costing \$1.35 and \$3.98 respectively. Their use in regulated supplies is shown in fig. 23. Their current limitation is set by the package dissipation: 0.8 watt at 25° C. This situation may improve with the introduction by G.E. of the new PA246, a five-watt audio amplifier.

The RCA CA3018 is another inexpensive IC that can be used as a regulator.¹² In this

case, an internal reference is provided (by an emitter-base diode in reverse breakdown), but an external series pass transistor must be provided. This is shown in fig. 22.

As a final note to the use of IC's as regulators, it is strongly advised that care be used in layout. Since monolithic integrated circuit technology is based on the silicon epitaxial process, IC's almost always have active de-

vices capable of oscillation above 100 MHz. Indiscriminate use of long wire leads, capacitor bypassing, and similar practices will usually make a power supply that can be

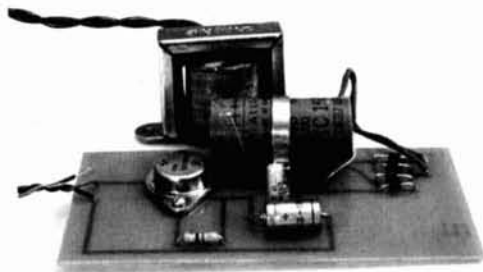

Simple emitter-follower regulated 12 V supply for transistor circuits.

heard on the local fm set—if the parasitic doesn't eat up the IC first.

week end project

Most transistor circuits use 12 volts as their power source, and if you like to experiment with these devices (who doesn't these days?), here's a simple supply based on the emitter-follower principle.* It will deliver 12 volts at either positive or negative polarity, at a load current of 0.5 ampere. Regulation and ripple attenuation will satisfy most requirements. Its schematic is shown in fig. 24. It has ten components, which works out to about a dollar per component, and you can make the printed circuit board yourself.

The photo of the PC board is the **positive**

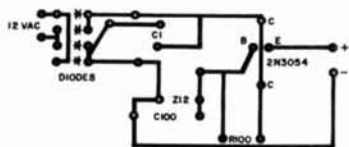

Printed-circuit board for the 12 V regulated power supply shown in fig. 24. A full-size template is available from ham radio magazine for 25c.

* The circuit of fig. 24 and the photographs were submitted by M. J. Goldstein, VE3GFN.

of the board. If you have a yen for photography, you can make a negative from which the board can be made. Another method is to trace the positive, turn the tracing paper over, and there's the mirror image. This is the actual diagram of the copper side of the printed board. Lay it out with Brady tape or acid resist, then etch away.

For smaller load currents, a smaller transformer can be substituted. Be sure the transformer output voltage is close to 12 volts, because any difference between transformer output voltage and 12 volts will be dissipated across the transistor.

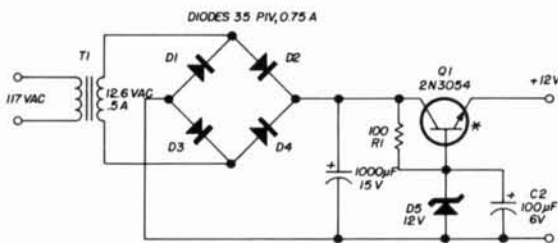

*MOUNTED ON HEAT SINK

fig. 24. A +12 V regulated power supply using a bridge rectifier and emitter-follower regulator.

references

1. H. Olson, "Some Thoughts on Transistor Power Supplies," 73, December, 1966, p. 10.
2. General Electric, "Reference Amplifier, Integrated Structures: RA1 A, B, C; RA2 A, B." Spec-Sheet 35.35, April, 1963.
3. Transistron, "Silicon References, Ref-Amp," Specification Sheet TE-1352E, November, 1968.
4. H. Wu, "Designing Power Supplies with FET's," *E.E.E.*, December, 1968, pp. 68-69.
5. ARRL, "The Radio Amateur's Handbook," 1962 edition, p. 234.
6. J. Stettner, "A Precision Regulated Supply Using WC-115 and WM-110," Westinghouse Integrated Application Note.
7. Beckman, "Model 802 Regulator Data Sheet 681223," Beckman Helipot.
8. H. Olson, "IC Regulated Supplies for Integrated Circuits," *ham radio*, March, 1968, p. 28.
9. Fairchild, "Application Notes, μ A723 Precision Voltage Regulator," 20-BR-0064-78, 1968.
10. Motorola, "Specification Sheet, MC1460, MC1560," DS 9104, September, 1968.
11. Fairchild, "Linear Integrated Circuits Applications Handbook," Fairchild Semiconductor, 1967, p. 144.
12. L. Toth, "Low-Cost Voltage Regulator from One IC," *The Electronic Engineer*, October, 1968, p. 89.

ham radio

For The Experimenter!

International EX Crystal & EX Kits

OSCILLATOR / RF MIXER / RF AMPLIFIER / POWER AMPLIFIER

Type EX Crystal

Available from 3,000 KHz to 60,000 KHz. Supplied only in HC 6/U holder. Calibration is $\pm 0.02\%$ when operated in International OX circuit or its equivalent. (Specify frequency)



\$3.95



OX OSCILLATOR

Crystal controlled transistor type.
Lo Kit 3,000 to 19,999 KHz
Hi Kit 20,000 to 60,000 KHz
(Specify when ordering)

\$2.95

MXX-1 Transistor RF Mixer \$3.50

A single tuned circuit intended for signal conversion in the 3 to 170 MHz range. Harmonics of the OX oscillator are used for injection in the 60 to 170 MHz range.

Lo Kit 3 to 20 MHz
Hi Kit 20 to 170 MHz
(Specify when ordering)



MXX-1



SAX-1



PAX-1



BAX-1

SAX-1 Transistor RF Amplifier \$3.50

A small signal amplifier to drive MXX-1 mixer. Single tuned input and link output.

Lo Kit 3 to 20 MHz
Hi Kit 20 to 170 MHz
(Specify when ordering)

PAX-1 Transistor RF Power Amplifier \$3.75

A single tuned output amplifier designed to follow the OX oscillator. Outputs up to 200 mw can be obtained depending on the frequency and voltage. Amplifier can be amplitude modulated for low power communication. Frequency range 3,000 to 30,000 KHz.

BAX-1 Broadband Amplifier \$3.75

General purpose unit which may be used as a tuned or untuned amplifier in RF and audio applications 20 Hz to 150 MHz. Provides 6 to 30 db gain. Ideal for SWL, Experimenter or Amateur.

Write for complete catalog.



CRYSTAL MFG. CO., INC.
10 NO. LEE • OKLA. CITY, OKLA. 73102

increasing the reliability of warning lights

Equipment
warning lights
must be reliable—
here's how
to increase their life

When an indicator lamp tells you something, it's important that the lamp be dependable. For example, if a dangerous situation is indicated by a red light, and a safe condition is indicated by that same light **not** being lit, you can imagine the problems that could arise if the indicator lamp bulb failed.

One of the criticisms of modern cars is the use of "idiot lights" to indicate critical items such as **OVERHEAT, NO OIL PRESSURE, DOORS NOT CLOSED, and BATTERY NOT CHARGING.** The logic is negative and not to be trusted. This accounts for the big sales of kits that return the car to the good old days of seeing what goes on by means of a direct readout instrument.

Let's extend this reasoning to indicator lamps used in electronic equipment. Most indicators are the **ON-OFF** type. This again points up possible dangers of depending on lamps to indicate a safe (**OFF**) condition.

When I leave my station, I take a fast look around to make sure that no indicator lamps or dial lamps are lit. I don't trust the lamps; yet I must depend on them, but only after doing something to increase their reliability.

Incandescent-lamp life can be extended considerably by simply lowering the lamp terminal voltage. This will, of course, reduce the light output. However, for simple **ON/OFF** indications, you can spare a lot of light and still get a satisfactory indication.

Lamp life extension can be dramatic. For example, if you reduce the rated voltage to one-half, the lamp life will be extended to nearly 4100 times longer than if you applied the full rated voltage. Typically, a lamp with a guaranteed life of 1000 hours will operate for 4,096,000 hours when operated at half its rated voltage.

Where does this magic number 4096 come from? It's based on the relationship of the ratio of the rated voltage to the derated voltage raised to the twelfth power, or:

$$\text{Life factor} = \left(\frac{\text{Rated Voltage}}{\text{Derated Voltage}} \right)^{12}$$

graphical solution

You can do the arithmetic the hard way and multiply the ratio by itself 12 times, or you can solve the problem with logarithms. Another way is to cut out **fig. 1** or (preferably) make a Xerox copy. Or you can make your own graph on a piece of five-cycle semi-log paper.

E. J. Case, W3NK, 2000 Kernan Drive, Baltimore, Maryland 21207

Fig. 1 shows that lamps can be as bright as you wish; lamp light will depend on the derating voltage ratio.

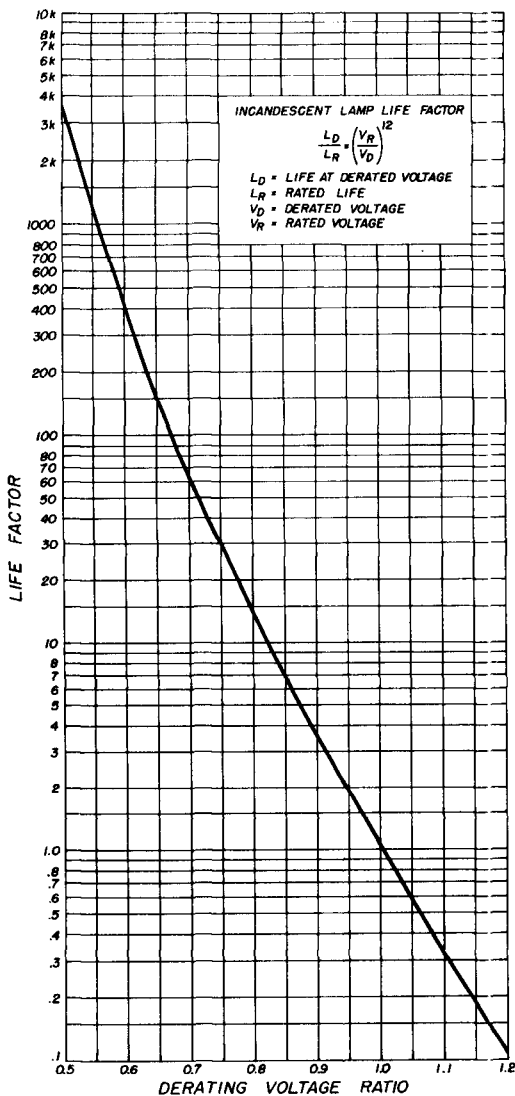

fig. 1. Effect on pilot-lamp life when a derating voltage ratio is applied. A small sacrifice in brilliance means a drastic increase in reliability.

an example

About five years ago, I got disgusted replacing Christmas-tree lamps and decided

to do something about it. I connected a 25 V, 2A filament transformer in series bucking to provide 90 volts, which was applied to the lamps. The voltage drop made a barely perceptible difference in brightness, but I haven't had to buy a bulb in five years.

Let's see what the 90 volts did for me. The rated voltage (for the series string) is 115 volts. I applied 90 volts. The ratio is 115/90, or 1.277. By the formula above, the life factor will be 1.277¹² or 19. So, whatever the rated life of these cheapies, they will last 19 times longer than when operated at 115 volts.

indicator lamp circuits

I modified the indicator lamp circuits in my ham equipment by adding series resistors. For type 328 lamps, I added a 22 ohm, 1/2 W resistor, which reduced the voltage from 6.3 to 3.15 V. Brightness is more than adequate; in fact, I'm tempted to reduce the voltage even further. The ratio 6.3/3.15 equals 2. When raised to the 12th power, this gives a life factor of 4096, or more than 4 million hours. This works out to about 467 years, so I think I'll let well enough alone.

For the type 47 lamps, a 15 ohm, 1 W resistor results in a terminal voltage of 4 V. The ratio is 6.3/4, which is a life factor of 233—still pretty good.

As mentioned earlier, the light intensity is reduced, but the life factor goes up much more rapidly than the intensity goes down.

The type 328 lamp gave more than adequate light at half voltage. The type 47 lamp, on the other hand, needed 4 volts to provide a comparable brightness. So do a little experimenting. Get the brightness you need, then do a little arithmetic or use fig. 1 to project the lamp life. Remember too, that overvoltage will shorten the life of your lamps just as dramatically.

In addition to peace of mind, look at all the money you'll save. In 100 years it will be enough to get that new rig.

bibliography

"Photomods Brochure," Clairex Electronics.

ham radio

build your own tilt-over antenna mast

Here's the answer
to a structurally sound,
low-cost mast
using ordinary hand tools
and readily available
hardware

This tilt-over antenna mast fulfills the need for a lightweight, low-cost amateur rotary beam support that can be raised or lowered in a few minutes by one man without assistance. As shown in the accompanying sketches and photographs, the design requires materials and tools commonly available to most amateurs, takes up only modest backyard space, and unlike lattice-type metal or wood towers, is quite unobtrusive, especially when painted to blend with the background.

The project originated when I was pondering ways and means for supporting a lightweight Mosley TA33 Jr. three-element beam. The obvious solution to the problem would be to purchase and erect one of a large number of available steel towers, but this was ruled out for esthetic and financial reasons. Using the rooftop or chimney was likewise unacceptable. One alternative remained; a new design had to be conceived that was structurally sound, low in cost, and easy to build and manipulate.

Over the weeks many ideas were tried and rejected, and during the construction period many revisions were made. The tilt-over mast and antenna have been in operation for several months, during which they've been lowered and raised many times without incident. I've included a detailed stress analysis, complete with quantitative data in this article (see Appendix). The analysis considers loads encountered in raising and lowering the structure, as well as those resulting from wind velocities up to 80 miles per hour.

Sidney Wald, W6KRT, 6430 Ellenvue Avenue, Canoga Park, California 91304

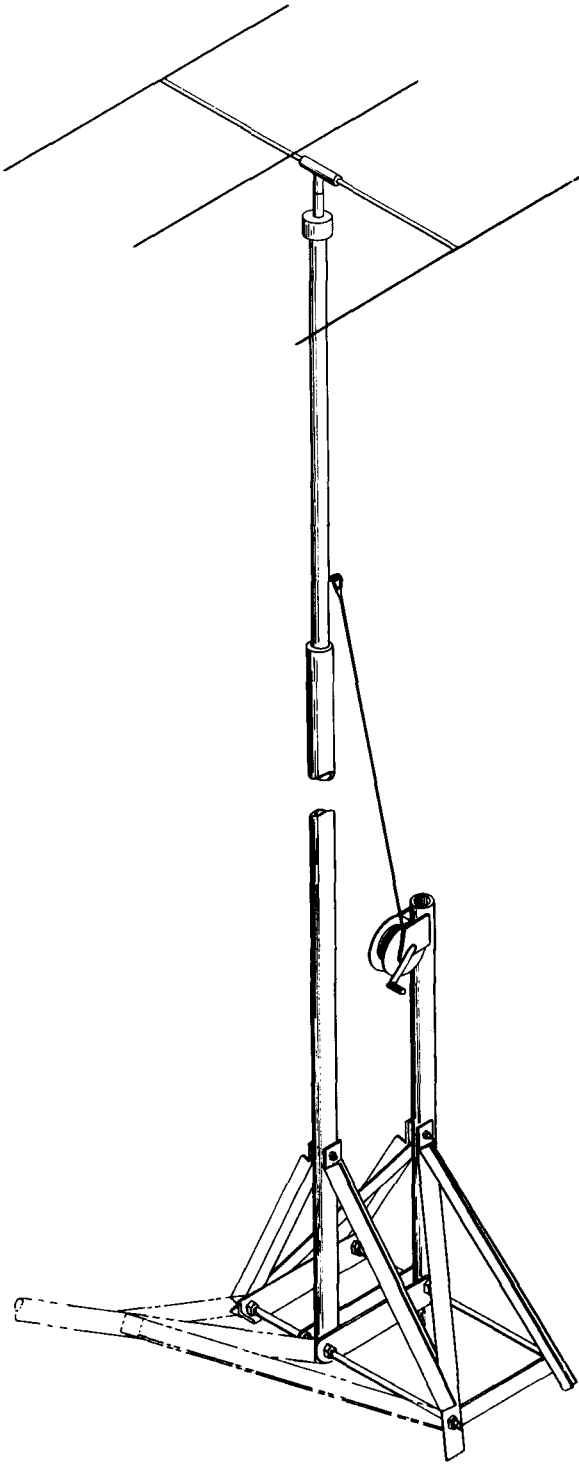

fig. 1. Complete tilt-over mast structure showing mast-hinge assembly.

Four novel features are included in the design and construction of the mast:

A boat winch mounted on a short, fixed support pipe for raising and lowering the mast.

A rigid hinge or pivot assembly at the base, which prevents lateral deflection of the mast and antenna assembly during erection.

Two sets of symmetrically placed guying cables to maintain the mast in the vertical position without buckling.

Auger or screw anchors in the soil as high-strength fastenings for the guying cables and winch pipe support.

In all cases, safety factors of at least 2 to 1 were used to compensate for any small design approximations and to insure adequate resistance to high winds.

construction

The first step in the project is to accumulate the parts listed in **table 1**. The only precaution here is to be sure to purchase 1/8-inch diameter, 1800-pound-breaking-strength stranded-steel aircraft cable and **not** galvanized iron sashcord (which resembles the proper material) with a breaking strength of only 540 pounds. Stainless steel cable is even better, but it's quite expensive.

The screw anchors may be obtained from Spaulding Products, Frankfort, Indiana. Other materials are obtainable from plumbing and hardware supply sources. The winch is obtainable from Sears-Roebuck at about \$6.00 for the smallest unit, with a capacity of 1000 pounds. Good construction practice for any device that must withstand weather calls for at least two coats of paint. Don't overlook this essential item.

ground work

Selection of a site comes next. Be sure that an unobstructed radius equal to the mast, plus antenna and rotor height, is available in the vertical plane for raising and lowering. In the example shown here,

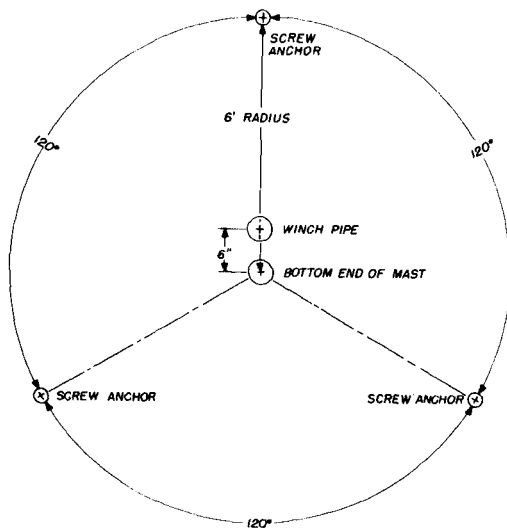

fig. 2. Plan view of the tilt-over mast base site.

this amounts to a distance of about 35 feet plus adequate clearance for the antenna boom and elements.

After you select the location of the mast

base and lay out the site as shown in **fig. 1**, drive the 2-inch pipe until it projects about 2 inches above the ground. This forms the socket that receives the 1½-inch winch pipe. (The location of this socket is about 6 inches to the rear of the bottom end of the antenna mast.) Then insert the 1½-inch winch pipe into the 2-inch pipe until the winch pipe bottoms. Fasten the assembly together with a 3/8-inch steel bolt, lock washer and nut. (See **fig. 2**.)

Next, drive the three screw anchors into the ground 120 degrees apart at a radius of 6 feet from the bottom end of the antenna mast as a center (see **fig. 1**). The technique for installing these anchors is as follows: After the location is spotted, make a shallow depression 6 inches in diameter by 6 inches deep. Then using a length of 3/4-inch pipe as a handle through the eye of the screw anchor, twist the auger end of the anchor into the ground, using downward pressure while

table 1. Parts list for the tilt-over mast.

part	description	quantity
galvanized iron pipe	2-ft x 2-inch diameter (nom)	1
galvanized iron pipe	7-ft x 1½-inch diameter	1
galvanized iron pipe	10-ft x 1½-inch diameter	1
galvanized iron pipe	21-ft x 1¼-inch diameter	1
extruded aluminum alloy pipe	3-ft x 1¼-inch diameter	1
boat winch	1000-lb capacity	1 (Sears)
aircraft cable	galvanized steel 1/8-inch diameter 1800 lb rating	210 ft
turnbuckle	5/16-inch x 6-inch	7
screw anchor	4-ft x 6-inch diameter helix	3 (Spaulding Products)
wire rope clip	1/8-inch	58
wire rope thimble	1/8-inch	39
galvanized or stainless steel bolts	3/8-inch diameter x 4-inch long	5
eye bolt, galvanized iron	3/8-inch diameter x 4-inch long	1
guy ring	To fit 1¼-inch pipe	1
threaded galvanized steel rod	½-inch diameter x 2 ft	2
galvanized angle iron	1¼-inch flange x 1/8-inch thick	15 ft
miscellaneous locknuts, lock washers and flat washers		30-40
paint		½ gallon

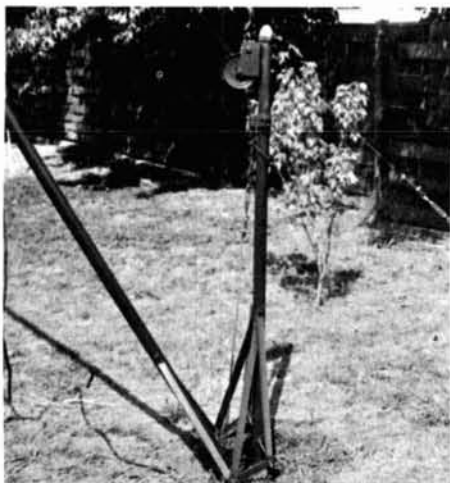

turning. Initial moistening of the hole may be necessary to start the anchor.

Twist the anchors into the ground until only the circular eyes protrude. When installed in average backyard soil, these anchors can withstand a pull of over 2000 pounds.

Mount the winch near the top of the 1½-inch pipe at a height of about 5 feet above the ground, using two 3/8-inch diameter steel bolts, lock washers and nuts.

fig. 3. Winch pipe support.

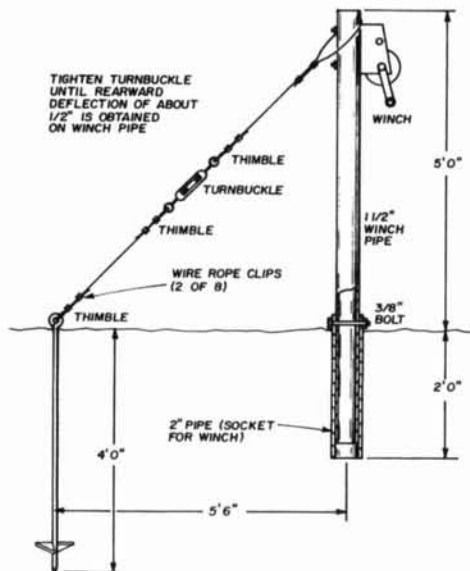

The top of this pipe is then anchored to the rearmost screw anchor eye by a tension assembly consisting of steel cable, turnbuckle, thimbles and wire rope clips as shown in fig. 2.

pivot assembly

The next step is the construction of the pivot, or hinge assembly about which the mast tilts. The basic materials here are

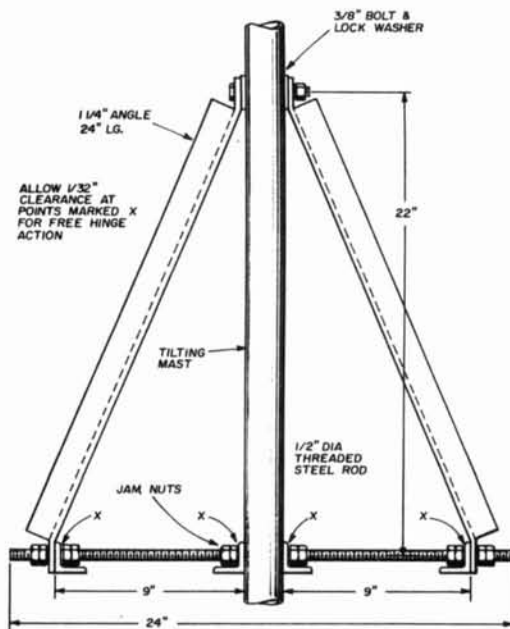

fig. 4. Mast hinge assembly detail. Leave nuts slightly loose to permit antenna mast to pivot; use jam nuts (two on each side) to secure.

various lengths of angle iron to form the rigid triangular gussets and the threaded ½-inch diameter steel rods that form the transverse axle and compression members as shown in figs. 3 and 4.

The flanges on angle-iron members are trimmed and bent at the ends to permit them to be joined as shown. When properly assembled, the hinge structure permits the mast to tilt about the pivot axis, while the axis is rigidly held in space by the balance of the triangular hinge structure. The latter is stationary with respect to the winch pipe. Tighten all nuts securely with

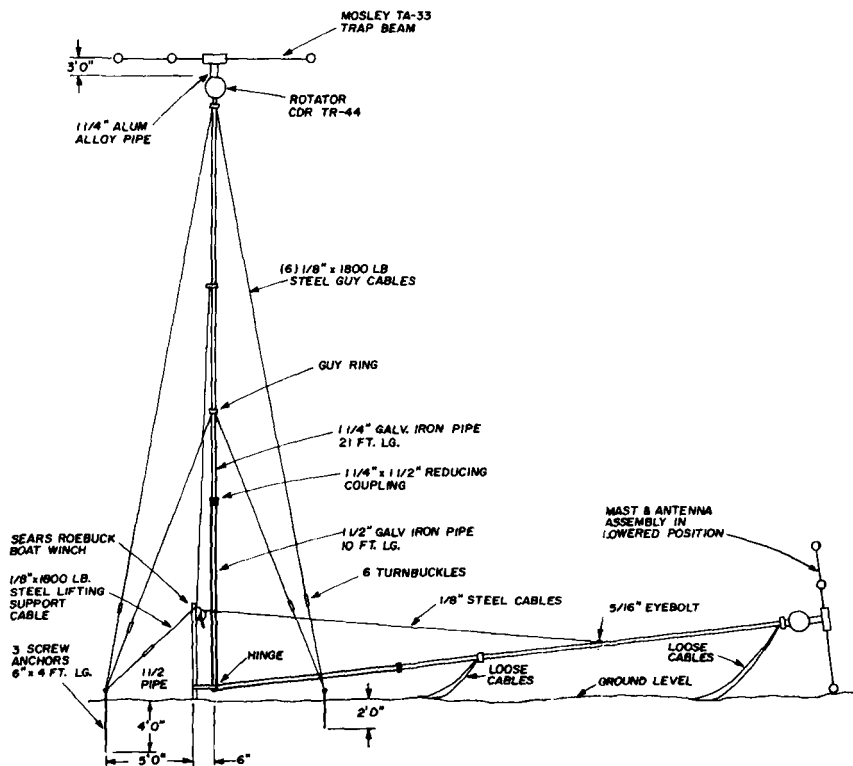

fig. 5. Completed tilt-over mast.

the exception of those on the pivot axis (fig. 3). These are left slightly loose to permit the triangular assembly on the antenna mast to rotate about the axis of the threaded rod. Be sure to use flat washers and lock washers, or locknuts.

The exact dimensions of the hinge assembly are not critical, and the sketches and photographs illustrate construction techniques. In general, the distance between mast and winch pipe should be kept short (about 6 to 8 inches). The triangular assembly of fig. 5 shows dimensions that will give adequate lateral support for the 35-foot mast.

mast assembly

The next step is to lay the 1 1/2-inch pipe on the ground and assemble it to the movable triangular hinged member via the two drilled holes, which receive the threaded rod and upper 3/8-inch bolt respectively. The assembly at this point

should resemble fig. 6. Now screw the reducing coupling to the free end of the 1 1/2-inch mast pipe, and then follow this with the 1 1/4-inch pipe.

You should now have about 31 feet of iron pipe on the ground. Drill a 3/8-inch hole 23 feet from the bottom end of the 1 1/2-inch pipe. This receives the 3/8-inch eyebolt, which will be the main lifting member when the mast is raised. (See

table 2. Parameters used in raising-and-lowering stress analysis.

part	lifting stress (lbs)	breaking strength (lbs)
main lift cable	539	1800
eyebolt	117	2000
winch pipe	117	—
winch	539	1000 (rated load)
winch support cable	737	1800

photograph.) Following this, attach the guy ring at the midpoint (16½-foot level), and fasten three guy cables to the ring using thimbles and wire-rope clips. Mount the antenna rotator at the end of the mast pipe assembly, and fasten three guy cables to the base of the rotator as shown in the photograph.

up she goes

At this time you're ready to raise the mast and rotator to about 8 feet, so that the beam can be assembled to the rotator. To do this, attach one end of a length of 1/8-inch aircraft cable to the 3/8-inch eyebolt, and attach the other end to the drum of the winch, allowing one or two layers of cable to accumulate on the drum before taking up tension.

If the winch is now cranked until the rotator clears the ground by 9 or 10 feet, an 8-foot ladder may be placed under the mast near the rotator, and the winch can be cranked backward until the mast is supported in part by the ladder.

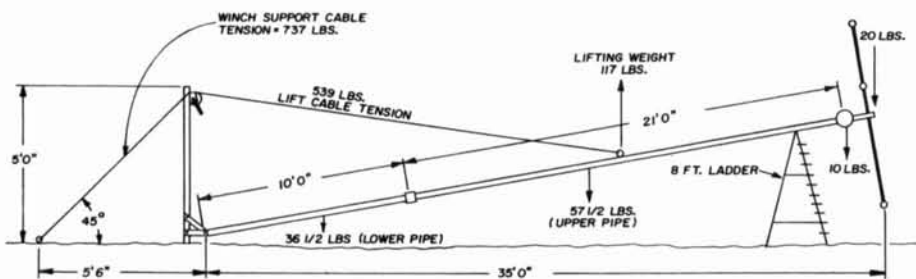

$$\begin{aligned} \text{Clockwise moments} &= (\text{beam wt} \times 35) + (\text{rotor wt} \times 31) + (\text{wt of lower pipe} \times \frac{10}{2}) + (\text{wt of upper pipe} \times 20\frac{1}{2}) \\ &= (20 \times 35) + (20 \times 31) + (36.5 \times 5) + (57.5 \times 20.5) \\ &= 2683 \text{ ft lb} \end{aligned}$$

$$\begin{aligned} (\text{lifting wt at eyebolt, } W_L) \times 23 \text{ ft} &= 2683 \text{ ft lb} \\ W_L &= 2683/23 = 117 \text{ lb} \end{aligned}$$

$$\text{Angle } A = \arctan 5/23 = 12.3^\circ$$

$$\text{Cable tension} = \frac{117}{\tan 12.3^\circ} = 539 \text{ lb}$$

Stress on winch pipe in compression is equal to $W_L = 117 \text{ lb}$

$$\text{Tension on winch support cable} = \frac{(539 \times \cos 12^\circ)}{\sin 45^\circ} = 737 \text{ lb}$$

Stress on screw anchor = 737 lb

fig. 6. Stress analysis for lifting operation.

The antenna assembly is now secured to the 3-foot length of 1 1/4-inch extruded thick-wall aluminum alloy pipe, and the pipe is inserted into the rotator and finally clamped into place. Since the TA33 Jr. beam weighs only 20 pounds, this operation is not too difficult.

The rest of the operation consists of raising the entire assembly gradually with the winch until almost vertical, attaching the two sets of guy cables to the screw anchors and bringing the mast into true vertical position using the turnbuckles for adjustment.

The tension in the lifting cable may now be reduced, since its function has been fulfilled, and it will not be used again until you want to lower the antenna mast.

The middle set of guys prevents the slender pipe structure from buckling while the main guy cables (attached to the ro-

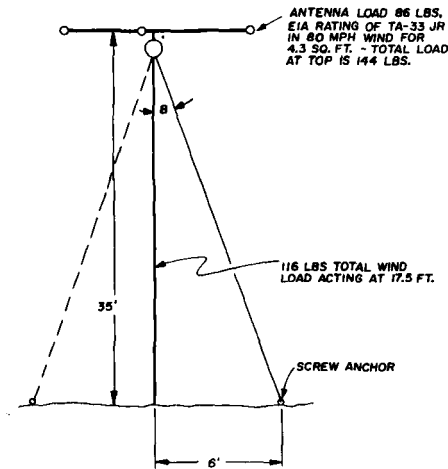

fig. 7. Wind load stress analysis.

table 3. Wind load stress analysis parameters.

part	wind load stress	load carrying ability
guy cable	870 lbs	1800 (breaking strength)
screw anchor (in dense clay soil)	870 lbs	2000 (holding strength)
rotator casting anchorage	7000 psi	14000-23000 psi (yield strength)

tator) maintain the mast in a vertical position. True vertical is established near the base, using a carpenter's level, while the upper part of the mast is visually aligned using neighboring structures as references. You can now stand back and proudly view your mast and antenna, which will appear as in fig. 7. Give them a coat of paint, and you're ready for many months of trouble-free operation.

$$\text{Angle } B = \arctan 6/35 = 9.7^\circ$$

Stress in projected area of mast pipe = approximately

$$\frac{(2 \text{ in} \times 420 \text{ in})}{144} = 5.83 \text{ sq ft}$$

$$\text{Mast wind load} = \frac{5.83}{4.3} \times 86 = 116 \text{ lb acting at half-way point}$$

This is equivalent to an additional wind load of $116/2 = 58 \text{ lb}$ acting at the top

$$\text{Thus, total wind load at top} = 86 + 58 = 144 \text{ lb}$$

$$\text{Assuming cable prestress of 25 lb, cable tension} = 25 + \frac{144}{\tan 9.7^\circ} = 870 \text{ lb}$$

appendix

stress consideration

Two separate structural stress situations were taken into account in the design of the tilt-over mast. The first occurs only during raising and lowering, while the second is concerned with resistance of the structure to high winds.

In the first situation the critical design parameters are:

1. Lifting cable tension
2. Lifting eyebolt strength
3. Deflection of the mast pipe assembly
4. Stress on the winch, winch support pipe and winch support cable
5. Tension on the screw anchor holding the winch support cable

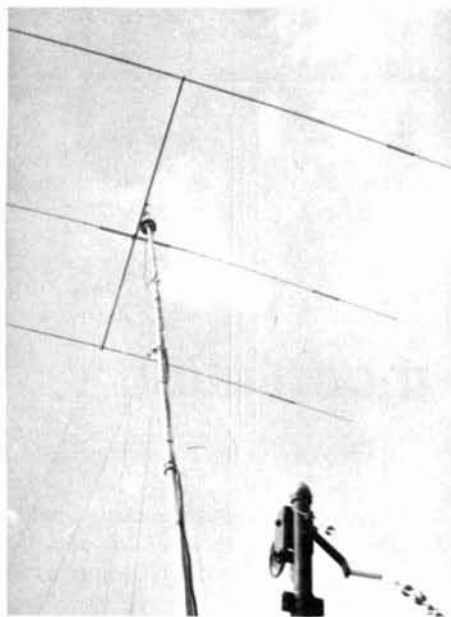

Referring to **fig. 8** a summary of these stresses compared to design breaking strength is shown in **table 2**.

Deflection of the mast pipe during lifting was a maximum of about 12 inches, which is well within safe limits for the 32-foot length of iron pipe. Once the assembly is in the vertical position, all stresses in the lifting components are relieved, with the exception of the winch-support cable, which may be maintained at some nominal tension (say 50 pounds) to keep the support pipe rigidly fixed.

Referring to **fig. 9**, the cable stress is 870 pounds compared to a breaking strength of 1800 pounds and a screw anchor holding ability of 2000 pounds. The cable-fastening point on the lower aluminum rotator casting will be subjected to a

stress of $\frac{870}{0.125} = 7000$ pounds per square

inch, compared to a yield strength of 14,000 to 23,000 pounds per square inch. **Table 3** gives the data.

It should be noted that all wind load stresses are based upon the Mosley TA33-Jr. EIA rating of 86 pounds for a projected area of 4.3 square feet at 80 miles per hour wind velocity.

ham radio

RCA has all-new FCC commercial license training

**Get your license—
or your money back!**

Now RCA Institutes Home Study Training has the FCC License preparation material you've been looking for—all-new, both the training you need, and the up-to-date methods you use at home—at your own speed—to train for the license you want!

2 Convenient Payment Plans—You can pay for lessons as you order them, or take advantage of easy monthly payment plan. Choose the FCC License you're interested in—third, second or first phone. Take the course for the license you choose. If you need basic material first, apply for the complete License Training Program.

SPECIAL TO AMATEURS. *This course is primarily for Commercial License qualifications. But it does cover some of the technical material that will help you prepare for the new Advanced and Amateur Extra class tickets. Check out the information the coupon will bring you.*

Mail coupon today for full details and a 64-page booklet telling you how RCA Institutes Home Training can show you the way to a new career—higher income—and your FCC License.

RCA



RCA INSTITUTES, INC.
Dept. 350-002-0
320 West 31st Street, New York, N.Y. 10001

Please rush me, without obligation, information on your all-new FCC Commercial License training.

Name _____

Address _____

City _____ State _____ Zip _____

a different approach to amplitude modulation

Expensive modulator
components
are eliminated
in this design—
modulation is provided
by the rf amplifier
power supply

A characteristic of conventional a-m transmitters is their bulky (and expensive) modulator, modulation transformer and power supply. How would you like an a-m transmitter capable of 100-percent modulation that doesn't require these components? The circuit described in this article may be the answer.

Although the system imposes a slight sacrifice in efficiency, this is compensated for by lower cost of original equipment, less weight, and smaller size compared to conventional a-m designs. Fewer components also mean increased reliability. This system uses a variable-current generator to modulate the output of a regulated power supply in accordance with the audio signal impressed on its input.

standard a-m system

A block diagram of a conventional a-m transmitter is shown in **fig. 1**. Typical waveforms, voltage, current and power are shown. Oscillator and microphone preamplifier power supplies have been omitted for simplicity.

With no microphone excitation, the carrier signal is unmodulated. The dc input to the rf amplifier is 15 watts. For 100-percent modulation, 7.5 watts of audio power are required from the modulator. Point X (**fig. 1**) then increases from zero to 30 volts.

Assuming class B modulation, 9.6 watts are required from the modulator power supply. The modulation transformer must be capable of handling the power in a linear

Courtney Hall, WA5SNZ, 7716 LaVerdura Drive, Dallas, Texas 75240

fashion. Since this transformer is costly, bulky and heavy (except in very low-power transmitters), it would be advantageous to eliminate it.

fig. 1. Conventional a-m transmitter with power requirements for 100-percent modulation.

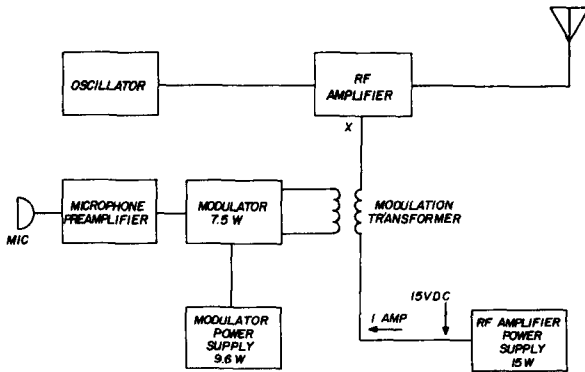

Additional savings in cost and size can be gained by eliminating the modulator. The circuit to be described requires no modulation transformer or modulator, but performs the same function by using the rf amplifier power supply regulator as a combination dc regulator/modulator.

circuit description

Fig. 2 is a schematic of a conventional regulated power supply that could be

fig. 2. Regulated power supply that could be used to power the rf amplifier in fig. 1.

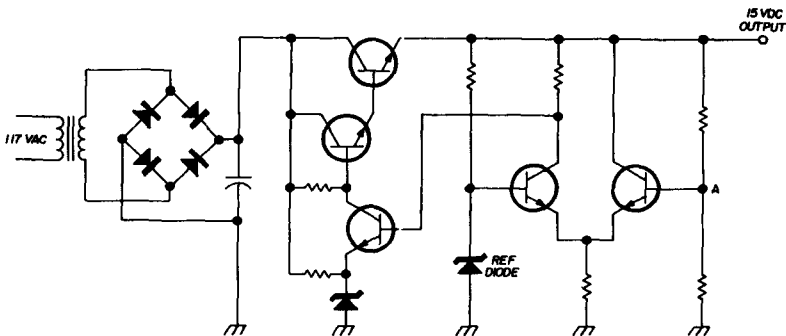

used to supply power to the rf amplifier. A sample of the output voltage (point A) is compared with the reference-diode voltage by a differential amplifier. The error signal at the differential amplifier output drives the series transistors, so that the output voltage is held constant as line voltage and load conditions vary.

If the modulator and modulation transformer of fig. 1 are to be eliminated, the output of the rf amplifier power-supply regulator must be made to vary from zero to 30 volts (for 100-percent modulation) in accordance with the audio modulation voltage waveform. Fig. 3 is a schematic of the power supply shown in fig. 2, but the circuit has been modified so that the output may be varied from zero to 30 volts by adjusting potentiometer Rp. This, too, is a conventional design.

Removing Rp from this circuit and replacing it with a variable current generator, so that the current through resistor Rf is made to vary with an audio modulating signal, will cause the regulator output to vary with the audio modulating signal. Thus the regulator will be modulated.

experimental model

Fig. 4 is a schematic of the modulated supply that was built and tested. Laboratory power supplies provided the input voltages to the regulator. A sine-wave audio generator was substituted for the microphone. The regulator output reproduced the sine wave without notice-

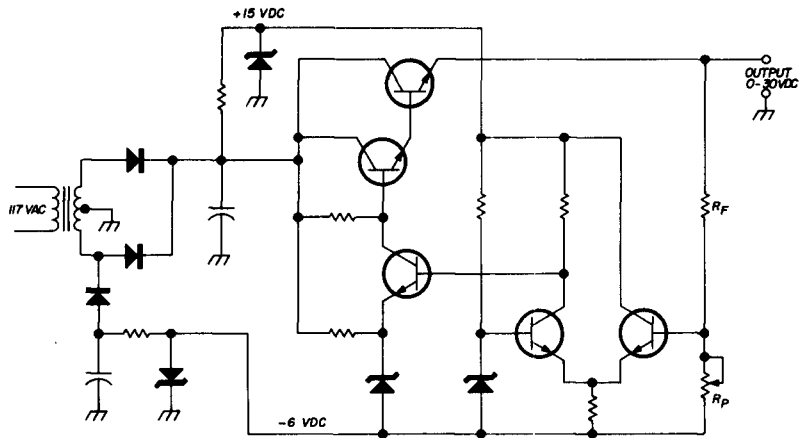

fig. 3. Modification of the regulated supply in fig. 2. Rp is used to adjust the output voltage.

able distortion with a peak-to-peak amplitude of 30 volts, both under no load and when driving a 60-ohm resistor. Frequency response was approximately 30 Hz to 25 kHz. The microphone preamplifier gain was sufficient to modulate the regulator to 30 volts peak-to-peak by speaking into the microphone in a normal voice. A block diagram of the modified a-m transmitter is shown in fig. 5.

Don Jackson, W5QAO, built a two-meter, 15-watt solid-state transmitter using

the basic circuit of fig. 4. It was necessary to feed the modulated regulator output to both the output stage and the preceding driver to obtain the proper modulation envelope. No other difficulties were encountered, and the transmitter is a compact, trouble-free unit.

Some power dissipation must be sacrificed in the regulator to make the system workable. Since the regulator must be capable of 30 volts peak output, its unregulated dc input must be about 35 volts

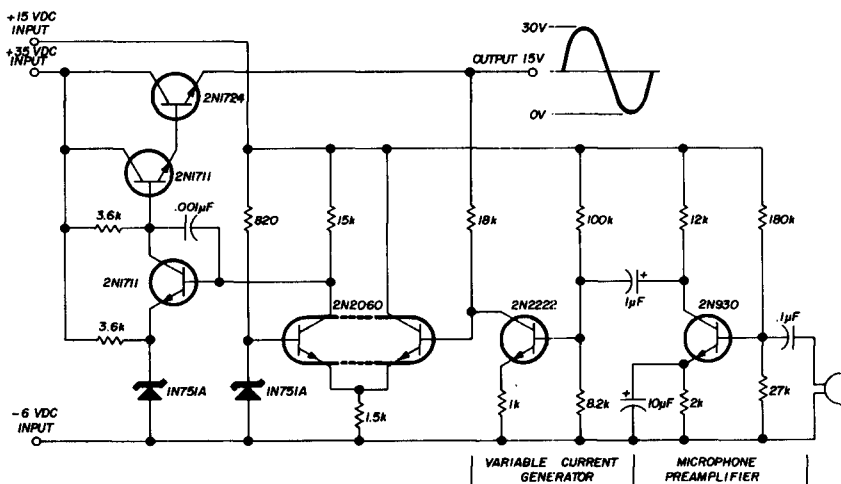

fig. 4. Experimental modulated power supply. The variable current generator is substituted for potentiometer Rp of fig. 1; regulator output then varies with the audio signal.

at an average current of 1 ampere. This is 35 watts input to the regulator, with only 15 watts average power out. The efficiency is about 43 percent.

In the conventional system of fig. 1, the combined power out of both modula-

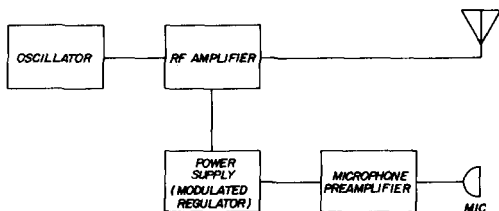

fig. 5. Amplitude-modulated transmitter with the modulated power supply.

tor power supply and rf amplifier power supply is 24.6 watts. Assuming an efficiency of 75 percent for these fixed-voltage power supplies, the input power to the two regulators is about 33 watts. Although the efficiency of the modulated regulator appears to be low, the total power input to the conventional system is only 6 percent less than the total power input to the modified system using the modulated regulator.

applications

Obviously this modulation technique can be applied to any transmitter. In general, the higher the transmitter power, the more desirable this technique becomes, since the eliminated components are more costly as power increases. It's doubtful if this system would be desirable in low-power, battery-operated transmitters of the walkie-talkie type since twice the normal battery voltage would be required. Voltage regulators are not normally used in these transmitters, so a modulated regulator may result in a net increase in components due to the modification, and savings from eliminating a 100-milliwatt modulation transformer may not be substantial.

ham radio

CQ de W2KUW

WE NEED YOUR SURPLUS TUBES

1P21	3CX2500
2C39	3CX3000
2K25	3CX5000
2K48	3CX10,000
2K (any digits)	3E29
3-400	3K (any digits)
3-1000	4-65
3B24	4-125/4D21
3B28	
4-250/5D22	4CX3000A/8169
4-400A/8438	4CX5000A/8170
4-1000A/8166	4CX5000R/8170W
4X150A	4CX10,000/8171
4CX250B	4X150G/8172
4CX250R/7580W	4PR60A or B
4CX300	4PR (any digits)
4CX250A/8321	5-125B/4E27A
4CX1000A/8168	
5R4WGB	304TL
6BL6	VA (all types)
6BM6 or 6A	250TH
6L6	450TH
7D21	450TL
8D21	QK (all types)
9C21	715C
9C25	802
75TL	
805	891R
807	TW (all types)
810	TWT (all types)
811A	NL (all types)
812A	4000 series
813	5000 series
832A	6000 series
833A	7000 series
891	8000 series

Please send us your surplus inventory lists. We want to buy other tubes and TX — RX — test equipment.

The TED DAMES Co.

308 HICKORY ST., ARLINGTON, N. J. 07032

Phone: 201 998-4246

NRCI's

NCX-1000

**the
Transceiver
of the 70's**



1 KW Solid-State Transceiver

Rarely is the amateur radio fraternity offered an important new product with the engineered-in reliability found in modern professional and military communications equipment. NRCI's new NCX-1000 is one of these exceptional products. It was conceived and developed for radio amateurs by the same company that gave the Marine Corps its rugged solid-state AN/GRR-17 tactical communications receiver, that gave the Navy its versatile AN/URT-22 exciter-transmitter, and that produced the classic HRO-500 VLF/HF receiver.

The NCX-1000 combines rock-solid design, exceptional performance, and a power punch. It's the finest solid-state, self-contained, 5-band kilowatt transceiver available today — the odds-on choice of the discerning amateur, be he rag-chewer or DX-er. See it now at your dealer's store, or write for complete details.

 **NATIONAL RADIO COMPANY, INC.**
NRCI 111 Washington Street, Melrose, Mass. 02176
617-662-7700

antenna systems for 80 and 40 meters

Some interesting ideas
for efficient
broadband antennas
for the lower-frequency
amateur bands

E. H. Conklin, K6KA, Box 1, La Canada, California 91011

You often hear references to antenna resonance, but with a lack of indication that the resonant frequency ever was adjusted or measured. Perhaps it is a good thing, for it might lead to confused thinking about the problem.

resistive mismatch

Take a very simple example—a half-wavelength antenna fed directly with 50-ohm RG-213/U coaxial cable (or 52-ohm RG-8A). The antenna is presumed to present a resistive load of about 72 ohms to the line or $R_R = 72 + j0$. The 50-ohm line needs a load of $R_o = 50 + j0$, but it is not getting it. The result, 72/50, is a standing-wave ratio of 1.44:1.

The amateur, it is presumed, doesn't actually know that his antenna is at resonance, and doesn't like the resulting swr, so he proceeds to run a curve of changing swr with frequency. Somewhere, at a nearby frequency, the swr bottoms out to a minimum that satisfies him, so he trims the antenna length to put this minimum swr at the desired frequency. Then, he claims that the system is "resonant." Why?

Had the line been a 72-ohm coaxial cable, the antenna load resistance $R_R = 72 + j0$ would equal the characteristic impedance of the line, Z_o , and everybody would be happy. The original an-

tenna would still be resonant, and the line would be "flat." That is, regardless of points along the line, or its length, the swr would be 1:1, it would load the transmitter well, and putting in a little more coaxial cable would not change anything.

The original antenna length, fed with the 50-ohm coaxial cable, would worry this chap because of the 1.44:1 swr. He might even add coaxial cable to improve the loading at some new cable length. What he really needs is something to transform 72 ohms at the middle of the antenna to the 50-ohm characteristic impedance of the line. With the transformation the swr at the sending end of the line would be 1:1, and again it would load well. This transformation could have been done in one of several ways, including a transforming bridge balun¹, tapping the line slightly up on a grounded (or ground-plane) vertical, with a stub, with an LC matching network, or with a quarter-wave transmission-line transformer.

finding resonance

How do you determine the resonant frequency of an antenna if the swr dip does not give it? One quad manufacturer says to insert a one-turn coil in the antenna and grid-dip it; but this may move the resonant frequency down a hundred kHz or more. The grid-dip frequency must be checked accurately, such as with a calibrated receiver. And it must be done so the grid-dipper doesn't come too close to the antenna, because that can lower the frequency too.

There are other ways. One is to feed the antenna when it is a continuous dipole, or a grounded vertical, and determine that the currents on both sides of a feed line are identical. A way to do this is to put two rf ammeters in a loop of wire, couple it inductively to an rf source to check meter calibration, and jumper this loop of wire, stretched out with the ammeters in the middle, across part of the antenna with the feedline connected between the meters (fig. 1). The frequency that produces identical current in

both meters is the resonant frequency.

This method works when the antenna is folded in the middle to produce a tuning or matching stub, as shown in fig. 2. However, it is also satisfactory to make a pick-up loop of several small turns of insulated wire, with ends about a foot long, and jumper this across two feet of the antenna. Then a grid-dip oscillator can be coupled to the small coil without it being in series with the antenna. The result is much more accurate. It works on quads, too.

reactive loads

You may have a resonant antenna with a load impedance (resistive) that is not equal to the characteristic impedance of

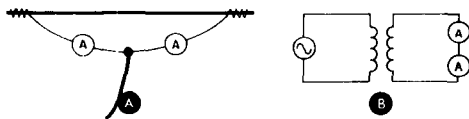

fig. 1. Determining resonance with rf ammeters. When the current through each ammeter in A is the same, the antenna is resonant. In B, the ammeters are placed in series to check that both instruments read the same.

the feedline. This results in standing waves although the line will present a resistive load to the transmitter when it is any multiple of an electrical half wavelength long. This load will be that of the antenna, which may or may not make the transmitter happy.

At any intervening length of feedline the actual impedance will be complex—that is, it will have a resistive and a reactive component. Some lengths of line may produce a combination of resistance and reactance that the transmitter cannot load because of matching network limitations. In this case, you can live with the high swr by adding sections of coaxial line until a length is reached that provides a more satisfactory load to the transmitter. The actual swr, however, remains the same.

Another solution is to add a series or parallel capacitor or inductor to the line to cancel the reactance.

When my Henry 2K is used on the wrong end of the 80-meter band, the tuning and loading controls no longer are where they were when feeding a dummy load; the tuning control is at maximum, and the loading control alone is adjusted for a plate-current dip, allowing no control over loading. As coaxial cable is added to the line the loading improves and the controls on the amplifier move toward the setting when feeding the dummy load.

bandwidth

If a dipole is used over a 12 to 14 per-

more with a 1.5:1 swr.

In the case of the inverted-V antenna, fortuitous height and apex angle may cause the antenna to present a 50-ohm load at resonance.⁵ Some increase in bandwidth may result as compared with a horizontal dipole in the absence of matching or broad-banding. Broadband impedance-transforming bridge baluns have been developed¹ for use when the antenna impedance at resonance does not match the transmission line properly. However, solutions by step tuning or by true broad-banding continue to be required, particularly for those whose antenna facilities are limited. Many of us need an antenna that covers 40 meters and both ends of 80 meters. We now have simple solutions

fig. 2. Determining antenna resonance with series rf ammeters in a matching stub, A, and with a grid-dip oscillator, B.

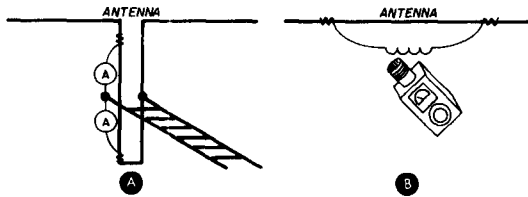

cent bandwidth in the 80-meter amateur band there are problems due to the change in complex antenna impedance presented to the feedline as the frequency is moved from one end of the band to the other. When the antenna itself is mistuned in order to terminate the line with a suitable amount of reactance to minimize the swr it may operate at a point on its reactance curve where small changes in frequency create large changes in reactance. This results in a narrowing of bandwidth, which might be defined as the bandwidth for an acceptable swr. A result of this condition was the development of in-band rf traps,² the use of coil switching at the antenna,³ end clip-on wires, and other means of enabling the antenna to be used over the entire 80-meter band. One approach⁴ used series capacitors, a stub of fanned-out wires to create a real 10 percent bandwidth or

for the 40-meter band and for spot frequencies of 3525 and 3825 kHz more or less, using the in-band traps or dual 80-meter wires, but we must develop a more general approach.

With the current 5-band DXCC interest in 80 meters, better solutions are needed. Frequently, one is caught with the end loading wires clipped on or off, presenting a 15-to-1 swr or worse at the necessary operating frequency. The system can be loaded with a suitable matchbox, or addition of coaxial cable, or lumped reactance, but there are added losses with such a high swr.

stub matching

Before leaving the general comments, let's take a quick look at some of the simple theory of stub matching. If an antenna is resonant and presents a satisfactory resistive load equal to the characteristic im-

pedance of the line, there is no problem. However, if the length of the antenna (or frequency) is changed it becomes reactive. If this length is selected to bring the resistive component of the complex impedance of the antenna, $Z_R = R + jX$ to a point where the R is equal to the characteristic impedance of the transmission line, Z_0 , a reactance (equal and opposite to the antenna's reactance) placed across the line will result in a match. The necessary reactance can be a stub. Usually a shorted stub is preferred. If you know the $R + jX$ at the center of the antenna,⁶ the stub length that can provide the cancelling $-jX$, can be calculated, read from a graph, or obtained from the Smith chart.

Let's look at the situation in another light; **fig. 3** shows a quarter-wavelength stub with a line attached at a point that gives a proper termination to the transmission line. The impedance of the shorted stub in one direction from the transmission line tap, a , is equal to that

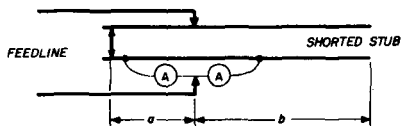

fig. 3. Line matched to stub; the reactance of the shorted section (A) at the line taps equals the reaction of the open section (B).

of the open stub in the other direction, b . The current flowing in one wire of the stub will be equal just below the line tap, and just above the line tap, when the stub is resonant. The open part of the stub can be bent out to form a dipole antenna, with the feedline conveniently located at the bend. This form of stub may shorten the dipole.

On the other hand, if you have an arbitrary length dipole and wish to feed it you may back down the line to the one or two points, a in **fig. 4**, in the first half-wave-

length toward the transmitter which has a resistive component (in $R + jX$) equal to the characteristic impedance of the line. At that point, attach a stub, b , which has an equal and opposite $-jX$ reactance, thus cancelling the reactance and matching the line with the resistive load from that point back to the transmitter.

smith chart

The Smith chart⁷ is a useful tool. A circle on it, centered on the center of the chart, is an *swr circle* for a lossless line. Points around this circle, which covers a half wave-length, gave the resistive and re-

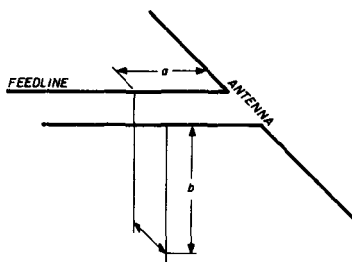

fig. 4. Method of stub-matching a reactive antenna. All lines can be coaxial cable.

active components of the complex impedance along the transmission line.

In reverse, any value $R + jX$ complex impedance can be plotted on the chart, such as the changing resistance and reactance as some circuit is fed at different frequencies. When these impedance points are connected together with a line it will be seen what range of frequencies falls within an acceptable *swr*. The Smith chart also facilitates adding reactances in order to bring some part—or a greater part—of the connected points within the acceptable *swr* circle, by moving a plotted point along a resistance curve by the amount of the added reactance.⁸

So far we have dealt with resistance, impedance and reactance. Sometimes problems are more readily solved in the reciprocals (these values divided into 1)

called conductance, admittance and susceptance. Whichever form is used, it is sometimes convenient to divide $R + jX$ by the characteristic impedance of the line, use the result in chart work or calculations, and then multiply again by the line's Z_0 to obtain the actual values of $R + jX$. This process is called "normalizing." One advantage of normalizing is that the value applies equally to lines of different Z_0 without replotting. Smith charts are available with a normalized 1 at the center for normalized data, and others are available with 50 at the center for direct use with 50-ohm systems.

about four turns were added; for 80-meter cw, about 9 turns were added.

An swr bridge showed something like 1.5:1 but there was no transmission line to have a standing wave. This actually was a measurement between the normal 52-ohm termination in the swr bridge, and the actual resistive load presented by the antenna. At any rate, the Heathkit SB200 and Henry 2K both fed the antenna easily, which was only 15 feet above ground at its midpoint. Nevertheless, cw and ssb contest contacts were made into far South America, Malaysia, Singapore, and the like on 80 meters.

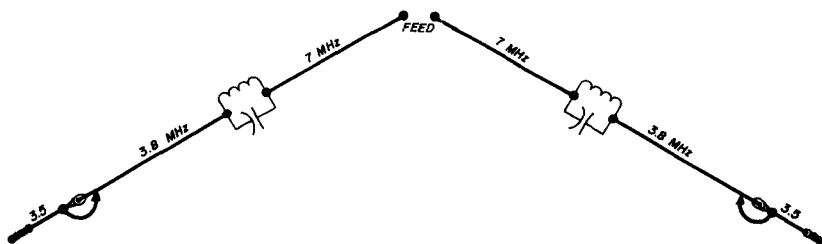

fig. 5. Trapped inverted-V with clip-on ends. Coaxial connectors are more reliable than alligator clips.

simple two-band antenna

When I was becoming more active in amateur radio after retirement, I didn't appreciate that the problem of coax-fed antennas for the lower bands might be difficult. With some memory of a chap named Marconi, and disregard for the 200-ohm resistance between rods driven in the ground ten feet apart, I put up an L antenna which was resonant at $5/4$ wavelengths to the 40-meter trap, and at $3/4$ wavelengths on 80 meters to the far insulator. The antenna was led to the transmitter output terminal with **no** coaxial cable at all, and **no** matching or coupling device. The wire was trimmed for the high end of both bands. Then, to move it to the low end of both bands, about ten turns of two-inch Air-Dux coil were mounted on the wall, and provided with a shorting clip. For 40-meter cw,

The main problem was the necessity to put 16 bypass capacitors and one rf choke in the electronic keyer, and to use RG-58/U cable instead of shielded audio cable to the exciter key jack to prevent rf from interfering with the keying. The antenna system was so simple, really, that it was a pity that use of the land was prevented by a building program. With the local decomposed granite soil, and pavement over almost all of the ground, all proposals that I use a vertical antenna and a radical ground were quickly rejected without a fair test.

two-band dipole types

The common two-band inverted-V or dipole is the trapped wire, fig. 5. This antenna may have considerable interlocking tuning between the sections. Furthermore, if any dead-end wire is twisted back

around itself, thus providing more wire if needed, it may load that section of the antenna unless it is shorted to the active wire by soldering or clamping with a Kearny clip. Even a loose fold-back may change the tuning by acting like a "fat" wire.

Another version is the use of two wires, each being a dipole for one of the bands; these wires can be at different angles, or spaced by dowel-rod spreaders, using a single support at each end, as in **fig. 6**.

These antennas may provide adequate coverage of the 40-meter band, but the

tend to shorten the resonant length by as much as 20 percent.

Everett⁹ goes through the design of a fat antenna with a bandwidth of about 30 percent within an SWR of 1.25:1. The length/diameter ratio of the conductor was selected for a resistive component that matches the transmission line; then a shorted stub was connected across the line at the antenna to cancel out the reactance.

John Kraus, W8JK,¹² gives the resistance of fat antennas which runs in the vicinity of 80 ohms at the center of a half

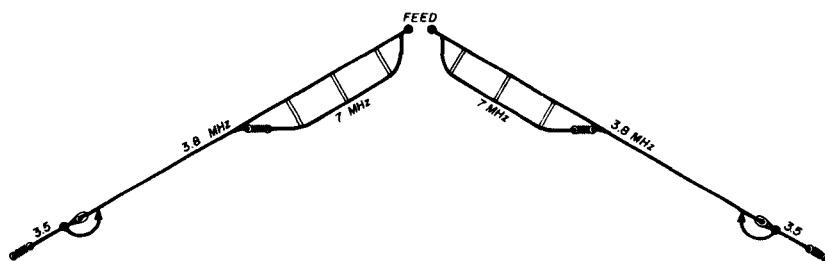

fig. 6. Two-wire, two-band inverted-V with clip-on ends.

width of the 80-meter band may be too much for them unless there is excessive loss in the line or balun. Line losses can be compared with those existing during earlier measurements, by logging the SWR when the far end of the line is shorted.¹⁰

broad-banding

On one band only, there are several ways to broaden the antenna. One way is to make the wire fat, in effect, compared with the length. Several spaced wires can be used, including the old "cage."¹¹ A remarkably effective and convenient form is to use several wires, held apart half way between the center insulator and the end by some type of light-weight spreader, forming a diamond in each quarter-wavelength. Still another way is to fan out two wires, or three, supporting the far ends from different points. All these

wavelength, to 200 to thousands of ohms for the center of a full wavelength. These lengths are much shortened due to the shape. The convenient impedance explains why many very broadband fat antennas actually are vertical half-waves or horizontal full-waves.

Coleman⁴ has investigated the use of parallel or series reactances in the form of capacitors, inductances or line segments, to obtain more bandwidth in a particular antenna. In connection with parallel-resonant stubs (usually slightly longer than a quarter wavelength) placed across the line at the antenna, he says: "The broad-banding property seems not to have been exploited. A resonant antenna has a negative susceptance (1/X) slope with respect to frequency, which can be cancelled with a properly chosen circuit over a considerable range of fre-

quencies. The most favorable antenna curve is one which has a resonant conductive component ($1/R$) just less than 2. The stub portion of a bazooka (quarter-wavelength-line type of balun) is ideally suited for bazooka matching and balancing of a balanced resonant circuit to an unbalanced line." Linear baluns thus formed of coaxial or triaxial¹³ cable may be very useful in broad-banding an antenna without added hardware.

Meier⁴ has put together the work of

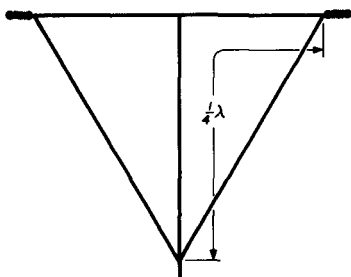

fig. 7. Fan monopole, physically short as shown. Two can be used as a dipole.

Coleman on the use of capacitors or inductors, and stubs, to obtain broad-banding. With simple antennas, and using a two-element broadening arrangement consisting of a series capacitor and a parallel stub, he obtained bandwidths far greater than our 80-meter band. Then, he explored the use of fan elements (fig. 7) which are physically short, and found that it was necessary to use only the parallel stub in order to obtain adequate broad-banding. Three wires, connected together at their far ends, were satisfactory; the length of the center wire plus half the length of the wire connecting the ends, was approximately a quarter wavelength.

The unusual bandwidth resulted partly from the complete loop that the antenna impedance makes on the Smith chart. The spiral locus is also typical of a series line transformer with a length that exceeds a quarter wavelength.⁹

It is customary practice in broadband

designs to sacrifice a perfect match at the midfrequency in order to gain bandwidth within the acceptable swr. For a fanned-out antenna and linear balun giving an swr less than 2.5:1 over the 80-meter band, (see the Radio Handbook, 17th Edition).

double-humping

Somewhat like broad-banding is the design of an antenna that will produce an acceptable swr at two different frequencies within the 80-meter band. One way is to clip additional wire on the ends of the antenna, but this sometimes proves to be inconvenient. A second way is to use in-band traps to do the clipping-on automatically.² It may be possible to use line sections as automatic switches¹⁴ even if a coiled coaxial line is used on only one side of the center of the antenna to perform the switching function, such as short-

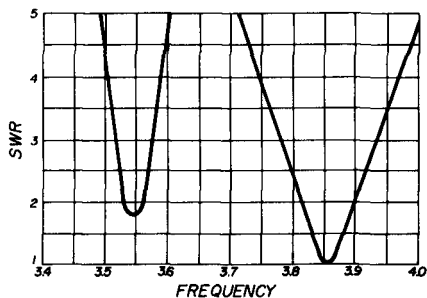

fig. 8. 80-meter antenna using two dipole wires within the band producing a double-humped swr curve.

ing a series capacitor or changing the length of a stub to its shorting bar or shorting line. I have tried separate dipoles cut for two frequencies in the 80-meter band (fig. 8). This worked satisfactorily except for the amount of wire in the air.

Two tests were made to solve the problem of midband operation. With the clip-on ends, leaving one on and one off, put the antenna swr dip in midband. This has not yet been tried with the in-band traps,

but clip-on wires hanging from the inside end of the traps successfully moved the position of the swr dip. This idea was first considered as a means of lowering the frequency of the ten- or fifteen-meter sections of the driven element of a Telrex Yagi without affecting lower bands appreciably, and without adjusting the aluminum tubing.

two bands broad-banded

Many of us have the more difficult problem of covering the 40-meter band at both ends, and the 80-meter band on both cw and phone. This tends to make the problem more difficult. The trapped 40/80 inverted-V with clip-on ends for the 80-meter cw frequencies which has been in use at K6KA for several years is some-

trap cut to different lengths for the ends of the 80-meter band. This caused a remarkable shortening of the wire length in addition to that caused by the inductive reactance of the trap, and only one swr dip was located within the transmitter's frequency range. The narrow frequency range of current exciters makes it difficult to locate the swr dips when they fall well outside a band.

Using two dipoles spaced six inches by dowel rods, the 40-meter wire below the 80-meter wire, and in-band traps near the end of the 80-meter wire, W6JKR found no interaction and fully satisfactory operation.²

Obviously, the in-band traps can be eliminated, too, by using three wires: one for 40 meters, one for 80 cw, and one for

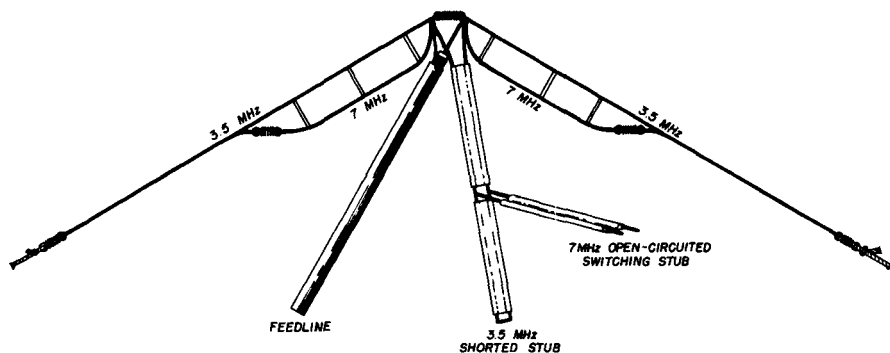

fig. 9. Broadband 80- and 40-meter inverted-V with tv shielded foam line shorted stub, and quarter-wave 7-MHz switching stub. This can be part of a bazooka balun.

what difficult to adjust initially because of the loading effects of the 80-meter sections upon the 40-meter section inside of the 40-meter Hy-Gain traps.

The need for clipping on wires was found unnecessary when an 80-meter phone dipole was placed in parallel with the old 80-meter cw dipole which was trapped for 40 meters. However, there continued to be some interlocking adjustments.

An alternate plan used one dipole from the center of the antenna to the 40-meter trap, and then two fanned wires from the

80 phone. Such an arrangement was put up at WB6ITO and WA7NAR using a wooden mast and a four-wire cage dipole on X-shaped spreaders. The wires are not connected at the far ends, but the lengths are cut for different frequencies in order to produce a fairly flat swr over the entire 80-meter band. One wire presumably can be cut for 40 meters. The problem of adjustment might be simplified by clipping extension wires on the three (or two) 80-meter dipoles not being adjusted, in order to move them out of the range of the dipole being adjusted. Actually,

the adjustment is not to "resonance," but to a low swr at the dipole's assigned frequency in the band.

general solution

So far several satisfactory one-coaxial-cable two-band antennas have been men-

2. A fan dipole with 40-meter traps in all of the wires, and a parallel quarter-wavelength stub (or slightly longer, possibly made of shielded tv foam cable coiled up) or bazooka with the automatic switching discussed above (see fig. 10).

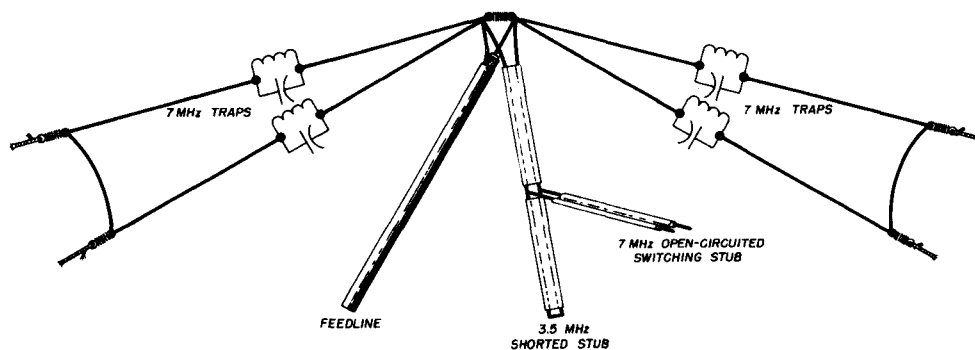

fig. 10. Broadband 80- and 40-meter fanned inverted-V, trapped for 40 meters. Stubs perform the same as in fig. 9.

tioned, including those with a separate wire for 40 meters, and two-point or wide-band coverage of 80 meters. If two coaxial cables are considered, the problem of obtaining broadband coverage of 80 meters is not difficult if a quarter-wave stub or bazooka balun is used for broadening.

For full coverage with a single feedline, other than the two cage dipoles described by Covington,¹¹ or a single cage which might permit trapping one wire for 40 meters, it appears that the most satisfactory design will use a combination of methods such as those discussed above and will be useful throughout both 40 and 80 meters with an acceptable swr. The most promising possibilities appear to be:

1. A 40-meter wire and an 80-meter wire, broadbanded by a parallel quarter-wavelength (or slightly longer) stub or bazooka whose length is automatically switched between bands by applying a quarter-wavelength open-circuited line at the position that will shorten the stub to the 40-meter length (fig. 9).

references

1. W. I. Orr, W. Sayer, "Wide-band Bridge Baluns," *ham radio*, December, 1968, p. 28.
2. R. Polansky, "Low-band Converted-vee Antenna," *ham radio*, December, 1969, p. 18.
3. N. E. Handel, "Novel Antenna for 80 and 40 Meters," *QST*, February, 1969, p. 40.
4. Bennett, Coleman and Meier, "The Design of Broad-band Aircraft Antenna Systems," *Proceedings IRE*, October, 1945, p. 671.
5. D. W. Covington, "Radiation Resistance of Inverted-V Antennas," *QST*, October, 1968, p. 36.
6. Strandlund, "Amateur Measurement of $R + jX$," *QST*, June, 1965, p. 24.
7. R. Hall, "Smith Chart Calculations for the Radio Amateur," *QST*, January, 1966, p. 22; February, 1966, p. 30; March, 1966, p. 76; June, 1966, p. 40.
8. K. Amis, "Antenna Impedance Matching," *CQ*, December, 1963, p. 65.
9. Everitt and Anner, "Communication Engineering," McGraw Hill (1956).
10. Cholewski, "Some Amateur Applications of the Smith Chart," *QST*, January, 1960.
11. D. W. Covington, "Inverted-V Radiation Patterns," *QST*, May, 1965, p. 81.
12. J. Kraus, W8JK, "Antennas," McGraw-Hill, p. 245.
13. J. Schultz, "Cable Pickup and Shielding," *73*, September, 1969, p. 36.
14. "Radio Communication Handbook, 4th Edition," Radio Society of Great Britain, 1968, p. 1373.

ham radio

quick band change

from six to two meters

If you like to operate
on both six
and two meters,
here's an equipment
changeover scheme
that is practically
instantaneous

My problem was how to get back and forth between 6 and 2 meters with this rather complex array of equipment: An Ameco TX62 (6- and 2-meter output on one coax connector); two converters, indicating lights; on-the-air light; and a speaker switch. One way would be to change a lot of coax cables, power cables, converter connections, etc. Meanwhile, the skip would have come and gone while thrashing around trying to get set up on the other band. A much quicker way is shown in **fig. 1**. Here's how I did it.

I had three surplus coax relays that came from an old vhf ARC-5 and a 12-volt dpdt relay. Coax relay 4 (**fig. 1**) was ordered from K8ZES, whose ad appeared in the August, 1955 issue of the *Vhfer*. These were two dollars post-paid at the time. They're smaller than standard coax relays. I used this to change my receiver input to either converter. Although these relays are 24- or 28-volt types, they've been working fine on 12 volts for three years. If you have a 28-volt coax relay, try it on 12 volts before you spend your hard-earned cash on another.

With all coax relays unenergized, the station is on 6 meters. Switch 2 is mounted on the mike. It energizes the on-the-air light (red jewel) and also energizes the dpdt relay, which disconnects the speaker and shorts the audio through a 10-ohm resistor. The other relay contacts ground the cathodes in the TX62. Coax relay 2 is

table 1. Parts data for the 6- and 2-meter switching circuits.

T1	Transformer, 110 V primary; 18 V 2$\frac{1}{2}$ A secondary
D1	Stud-type (unmarked) rectifier from Polypaks
Bulbs	12 V bayonet type number 1820 mounted in holder with colored jewel
Coax relays 1 through 3	war surplus salvage
4	see text
SW1	dpdt toggle switch
SW2	modified microswitch mounted on microphone

W. G. Eslick, KØVQY, 2607 E. 13th Street, Wichita, Kansas 67214

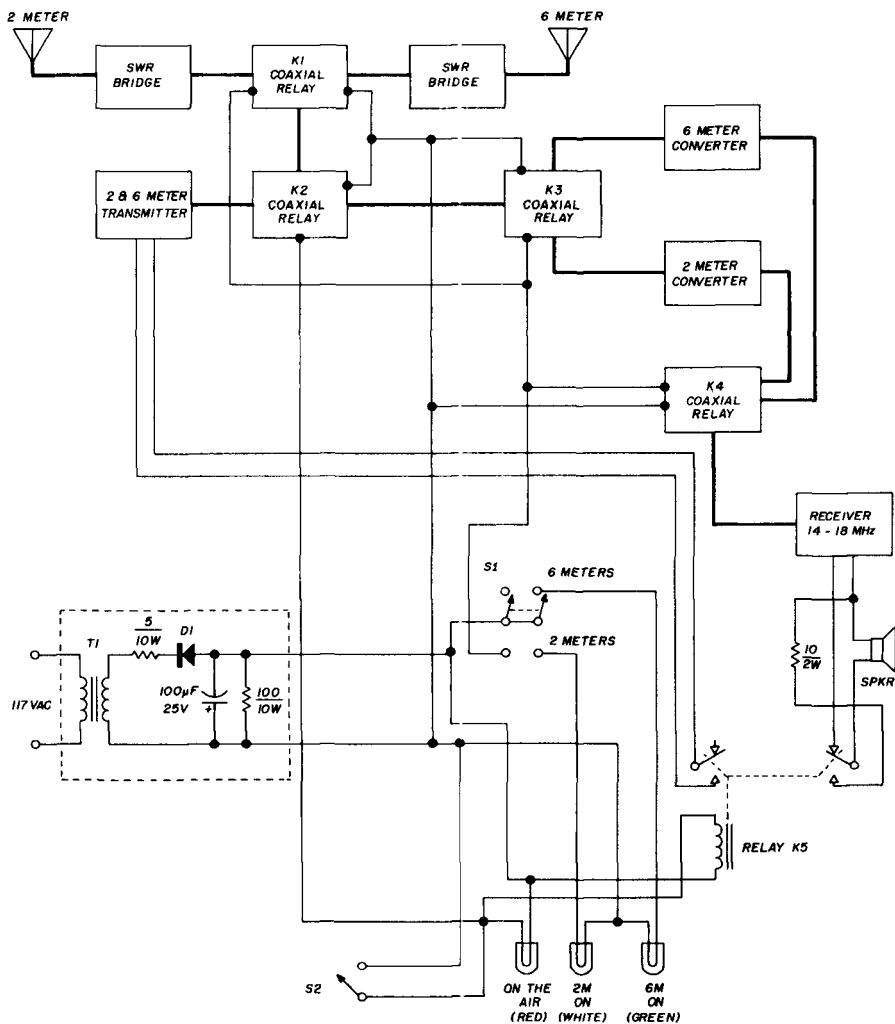

fig. 1. Switching circuit for quickly changing between 6 and 2 meters. Coaxial relays are coaxial dc-operated types. Heavy lines represent coaxial cables.

changed from receive to transmit through the coil of relay 5.

Throwing toggle switch 1 to the 2-meter position lights the 2-meter indicator light (white jewel), selects the 2-meter antenna via coax relay 1, connects the antenna circuit to the 2-meter converter via coax relay 3, and connects the output of the 2-meter converter to the receiver. With toggle switch 1 in the 6-meter position, everything is connected for 6 meters, and the 6-meter light is on (green jewel).

This may sound complicated to some and may be too much of a lashup for others, but it's easy to work. With switch 1 up and the

green light on, after I throw the master switch that turns everything on, I'm listening on 6. I press the mike switch, and I'm on the air. If I want to go to 2 meters in a hurry, all I have to do is place toggle switch 1 in the down position, the white light goes on, and I'm on 2 — just that simple and fast.

Additional information on the parts I used is given in table 1. (Other parts are as marked in fig. 1.) If you're interested, the swr bridges were made from an article entitled "Vhf Monimatch" in the *Radio Amateur's Vhf Manual*.

ham radio



the ham notebook

converting the hallicrafters SR-160 to an SR-500

While considering the purchase of either a used Hallicrafters SR-160 or an SR-500, I was looking over the two instruction manuals. The schematics showed that both units were identical with the exception of the final amplifier tubes. The circuits were the same, and even the same components were used in both final amplifiers. Because of this similarity, it's a simple job to convert the SR-160 to an SR-500.

Before converting the transceiver, you should think about the new power requirements. It's not economically feasible to convert the SR-160 power supply, since this would require a new transformer, new diodes and new liter capacitors for the high-voltage supply. The most economical way is to sell the old SR-160 power supply and buy a used SR-500 power supply. According to current used-equipment prices, it should be possible to swing this deal with a cash difference of about \$25.

The other approach is to build a supply for the converted SR-160/500 from scratch, and you could keep the SR-160 supply for later conversion to original configuration for resale.

If you build your own power supply it must provide the following voltages:

- 280 Vdc, 100 mA
- 750 Vdc, 50 mZ
- 80 to -130 Vdc, 10 mA
- 12.6 Vac, 5A

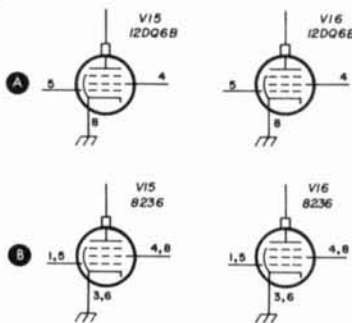

fig. 1. Converting the Hallicrafters SR-160 to an SR-500. Original SR-160 final amplifier wiring, A, and the SR-500 circuit.

Once the power supply is taken care of, the modification of the SR-160 is as follows.

Remove the two 12DQ6B final amplifier tubes from their sockets. Rewire the socket connections to the final amplifier tubes as shown in **fig. 1**. Install two 8236 tubes in the final amplifier sockets.

Readjust the bias for an idling current of 100 mA, using the method outlined in the SR-160 instruction manual.

Due to the similarities of the two equipments, the SR-160 manual and the SR-500 manual are identical. Note the changes made in the final amplifier socket wiring and the new idling current required in the bias adjustment.

As a matter of interest, I noted that the picture of the SR-160 bottom chassis view (Figure 13 of the manual) had been used in the SR-500 manual. It was possible to make this identity by checking the pin connections to the final amplifier tube sockets.

If you have an SR-160, this is an easy way to beef up its output a little.

Al Brogdon, K3KMO

impedance bridge

Here is a useful little bridge that can be used to compare the impedance of an unknown antenna (or network) to a known termination over the range from 2 MHz to 900 MHz. By changing the value of the

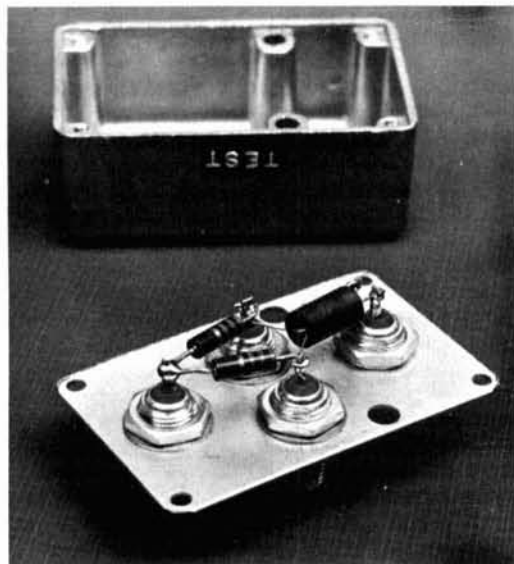

Construction of the impedance bridge. Unit must be housed in a metal box.

termination, impedance can be checked in the range from 25 to 500 ohms; to check the match of a 50-ohm antenna for example, a 5-ohm load would be placed across the *termination* terminals. When the impedance across the *test* terminals is equal to the

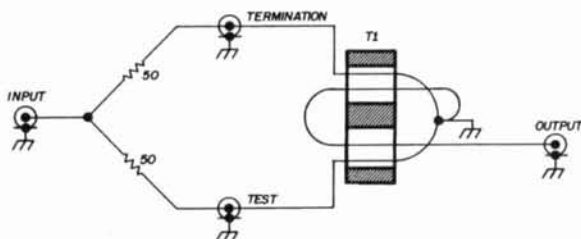

fig. 2. Impedance bridge compares "termination" impedance to the "test" impedance. Transformer T1 has two windings; each winding is one turn through a small double-hole toroid, the windings connected as above.

impedance across the *termination* terminals, there is no output.

This bridge may be used with a sweep generator and oscilloscope to display a circuit's resistance characteristic over the desired bandpass. To determine the value of an unknown impedance connected at the test socket, a calibrated variable resistor may be used at the termination terminals. When building this simple instrument, make sure all lead lengths are equal. It is not necessary for the impedance of the measuring equipment connected across the *input* and output terminals to have the same value as the unit under test.

Oliver W. Swan, W6KZK

instant replay

Does your tape recorder sit idle while you're on the air? All you need is a continuous tape loop, of as long a length as practical in your shack, made by slicing and joining both ends of a length of tape. With appropriate "jury rigging", such a loop can run forever without snagging. Continuous-loop automotive cartridge recorders such as the Sony TC-8 could also be used.

Whenever you do a bit of listening on the bands, run the recorder, either directly from the receiver's speaker output, or simply through the recorder's mike, placed near the speaker. Leave the machine in the "record" position; you will, at any given moment, have the most recent sounds (or minutes) of received signal, depending on loop length, which can be instantly replayed by quickly switching to the play mode. Why? Imagine this:

1. As a novice, you're trying to copy a signal slightly above your maximum cw receiving speed, to help improve your own speed. You got nearly all, but what did you miss? Flip to "play", cut the recorder's speed from maximum where the loop was originally run down to minimum. If your recorder has two speeds, you'll have halved the original wpm to a more comfortable level. If it has three speeds, you can cut down to one-quarter of the original speed.

2. You're a DX hound, on cw or phone, and you think you've just heard an unbelievably rare one. Or was it? Play it back again, maybe twice, before trying to call. Too bad! It wasn't ZK3JO . . . just K3JOZ.

3. You're handling traffic when a noise in the shack distracts you. You've missed an important part of the message. Ask for a complete repeat? That won't be necessary if you've caught the missing section on tape.

Of course, a tape loop isn't absolutely necessary; you could record the entire operating session on a full reel to be replayed when a log entry is to be clarified, and re-recorded on the same tape during the next session. But a loop, especially a short one, eliminates the time and uncertainty of fast rewinding. Experiment with different loop lengths (times) to find the length best suited to your operating habits. Using a loop is like having an insurance policy. You'll begin to appreciate it the first time you really need it.

Bob Hirschfeld, W6DNS

using an outboard receiver with the SB-100

The following idea is offered as an addendum to a similar item that appeared in an earlier issue of *ham radio*.* In my case, it was a simple matter of rewiring two sets of contacts on my Heath SB-100 antenna T-R relay so I could use a separate receiver with the unit. I wasn't concerned with switching the two audio outputs to a single speaker, as shown in the previous article, so no provision was made for this.

The before-and-after circuits are shown in fig. 3. I'm not familiar with the differences between the SB-100 and the SB-101, but if the T-R relay setup is similar in the two units, the modification should also work for the SB-101.

Bill Clements, K4GMR

*Jim Fisk, "Using an Outboard Receiver with a Transceiver," *ham radio*, September, 1968, p. 12.

soldering tip

Dig around the lumber yard for a scrap of lumber with a big end-grain knot, the sappier the better. Make a depression in the knot to hold a drop or two of solder. Then, when you want to clean and tin your iron, just rub the tip on the knot. Cover the bottom of the knot to keep it from glopping up your bench.

James T. Lawyer

LPY antenna

Unfortunately two of the driven elements were transposed in fig. 5, page 13 of the July issue; the positions of the third and fourth driven elements should be reversed. If the antenna is built as shown there will be a serious loss of gain.

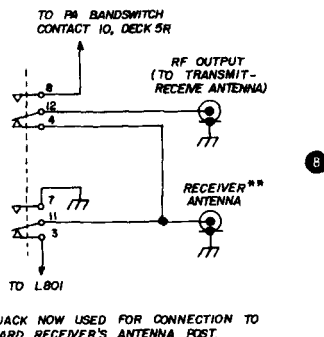
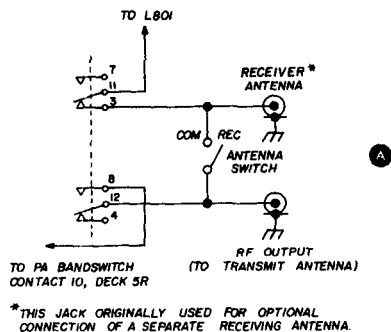

fig. 3. Original, A, and modified circuit, B, showing SB-100 T-R wiring for outboard receiver; no new parts are required.

watts up?

SR-2000 that's what. the Hallicrafters SR-2000 transceiver is packed with watts. 2000 watts. that's WATTS of power. you can buy it today.



FEATURES: < 1 KC readout • exclusive RIT (Receiver Incremental Tuning) • AALC Amplified Automatic Level Control • built-in Noise Blanker • 100 kHz crystal calibrator, VOX, PTT, Break-in CW • < 1 uv sensitivity for 20 db S: N/N • compact rugged cabinet • 2000 watts SSB, 1000 watts CW in a package only 7¼ x 16½ x 15 inches • P-2000 AC power supply including built-in speaker, final amplifier plate metering, 110/220 VAC • See WATTS UP at your local Hallicrafters distributor today.

the hallicrafters co.

A Subsidiary of Northrop Corporation



600 HICKS ROAD

ROLLING MEADOWS, ILLINOIS 60008

a mobile mount bracket

Serious thought must be given to mounting a transceiver in the front seat of today's new cars, because the bracket normally accompanying the equipment won't allow suffi-

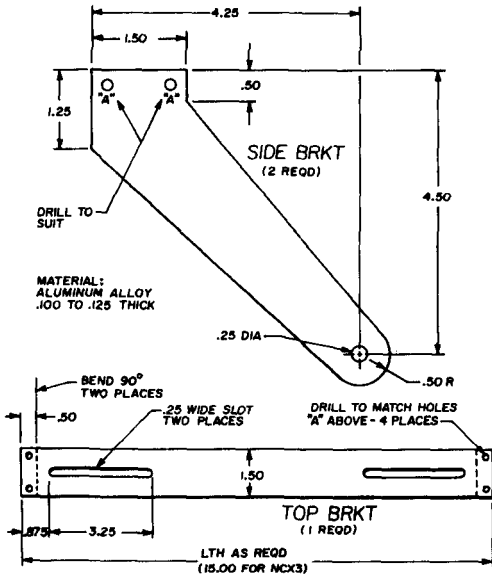

fig. 4. Homemade mobile mount bracket.

cient clearance above the hump in the floorboards when the equipment is bolted under the dashboard.

I found it necessary to design a mobile mount bracket with a slightly different shape to fit my NCX3. Also I recalled the many times my wife had caught her stockings on the arms of the old bracket when I had the rig out of the car. So with all that in mind, the design in fig. 4 was created, and the side arms were made removable.

I constructed the bracket from a 1½-inch piece of 5052-H32 aluminum alloy with a hardness index of 46. However, any hard aluminum that can be bent 90° will suffice. I cut it the same length as the bracket that came with the equipment so that when ½-inch right-angle lips were formed at each end, it fitted over the transceiver case. PEMNUTS with 6-32 threads were fitted into the ½-inch lips, and, of course, the body of the bracket was cut so that when fastened under the dashboard, the bracket could be slid

either way for proper positioning. The arms were fashioned as illustrated, but as each car is different, their angle may vary. This can be determined almost by the naked eye. The arms are fastened by 6-32 screws that go through the neck of the arms and into the PEMNUTS.

The result is a very firm installation. When the rig is out of the car, the arms are put into the glove compartment, and the wife's stockings and shins are safe. WA4KDI did the mechanical design.

Gay E. Milius, Jr., W4NJF

pentode replacement

Many amateurs are updating their old equipment by replacing vacuum tubes with semiconductors. Bipolar transistors are used occasionally, but the trend seems to be to junction fets and mosfets, with mosfets taking the lead. Jfets are a little harder to use, but not much, and they are still lower priced than rf-rated mosfets. The circuit shown in

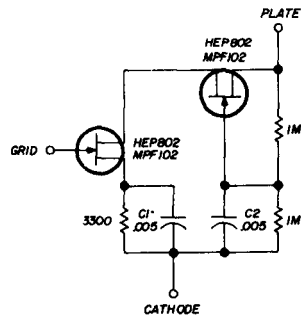

fig. 5. A simple solid-state circuit that can be used to replace vacuum tubes in simple amplifier circuits.

fig. 5 is a simple cascode circuit that may be used as a simple plug-in replacement for most pentode vacuum tubes. The circuit shown here works well up to 30 MHz; for higher frequencies bypass capacitors C1 and C2 should be reduced to 0.001. When using this circuit, make sure that the voltage at the "plate" terminal does not exceed 50 volts. Current drain of the circuit is about 600 microamperes.

Jim Fisk, W1DTY

Tomorrow's state of the art today . . .

THE NEW VARITRONICS/INOUE

DELUXE IC-2F

AMATEUR 2 METER FM TRANSCEIVER



All the features of the now famous FDFM-2S are combined with the most up-to-date technology and even smaller, smarter styling to make the Deluxe IC-2F an extraordinary amateur 2 meter FM transceiver. Look at the specifications of this beautiful, all solid state equipment . . .

TRANSMITTER: RF input power—20 watts; RF output—10 watts *minimum*; maximum frequency deviation—15KHz (adjustable); Automatic Protection Circuit (APC)—NEW! Not offered in any other transceiver on the market. Absolute assurance of final PA protection from shorted or high VSWR antennas by instantaneous transmitter disabling; Electronically switched—no relays; Sealed low pass filter to eliminate spurious radiation.

RECEIVER: Double conversion superheterodyne; Sensitivity better than $0.4\mu\text{V}$ @ 20 db of quieting; FET front end; ceramic filters for excellent bandpass shaping; Integrated Circuit IF; built-in speaker on front panel.

GENERAL: Six channels (six transmit and six receive crystals) selectable from the front panel; large RF/"S" meter and easier to read controls; power requirements 12 to 15 volts DC.

The Deluxe IC-2F comes complete with high impedance microphone, three-position chrome mobile mounting bracket, crystals installed for two channels (Ch. 1, 146.34/146.94; Ch. 2, 146.94/146.94), power cables and plugs and manual. **Amateur Net \$349.95**

Optional AC Power Supply with built-in Discriminator Meter, Model IC-3P. **Amateur Net \$49.95**

Available at your dealer

VARITRONICS INCORPORATED

3835 North 32nd Street • Suite 6 • Phoenix, Arizona 85018

SEE THE IC-2F AT SAROC IN LAS VEGAS, February 4-8



comments

Dear Mr. Bonadio:

I am one of "those Engineers" you are talking about. I would like to make some comments regarding your antenna, and also about science in general. Many discoveries are made by people not trained in the field, and anyone who makes one deserves a lot of credit because he starts with a distinct disadvantage. He has to try everything: things that can pay off as well as those things that cannot because of physical laws against them. An additional disadvantage is that the untrained inventor fails to see the commonalities inherent in many designs that look quite different.

There is no question in my mind that the antennas you describe work as described and in many situations will give better results than the beam antenna next door. That still does not mean that they are superior antennas in general. This, I think, is the reason why you could not sell them to manufacturers.

The "square diagonal" antenna has the characteristics of a dipole. You give directions for switching its (horizontally polarized) pattern by 90 degrees by means of relays. By adding two more positions on the switch you can switch the beam 45 degrees at a time. Just open up one set of dipoles at a time. The antenna

Mr. Bonadio replies:

Yes, I've tried to violate some of what we believe to be physical laws, because I don't trust everybody else's beliefs either. What I was originally trying to do was to broadband a doublet. I did. I then went to logical extremes. Then I could switch it and keep it in tune—at fabulously low Q. Then the ridiculous reports started coming in. These were on comparative strengths from DX and fading comparisons in round tables. This was from two dimensional elements. So, naturally, I tried three dimensions. The ratio of reports improved. Enthusiastically I tore down my old comparison antennas. Then I idealized the three dimensional effect in the six-element space dimension antenna, and found it better than the four- or eight-element systems.

I sent the editor of ham radio a list of about 100 ridiculously good reports from my modest operating before he would accept my article. Operated correctly, these antennas are actually very effective. However, sales to a manufacturer are based on that manufacturer needing the item for his profit picture. After amateurs prove that these antennas have a desirable place in sales, manufacturers can be interested, not before.

The third paragraph's first sentence is in error. A dipole has extremes of reactance and a high radiation resistance and launches a wave from an element laying in one dimension. My square diagonal has unusually low and smooth reactance curves and a lower radiation resistance, and launches a wave from "an element" in two dimensions 90° apart, which gives a complex wave. The extra position on the switch would require a second set of tuners, as the electrical appearance to the feeders of a two-wire dipole is grossly different from a four-wire load. The pattern differences are now modest on the four wire systems, so that four patterns in place of two would be undesirable encumbrance. I compared virtually every contact for a year between a 162-foot dipole and an equivalent 81-foot square square-diagonal antenna on 160 through 10 meters. One never performed "exactly as" the other.

will perform exactly as a rotating dipole with the advantage of quick pattern change.

The "box diagonal" antenna is identical in pattern and polarization as above. It simply uses more hardware for the same result.

The "space dimension" antenna has the performance, pattern and polarization of a dipole that can be inclined at various angles to the horizontal and rotated in azimuth, by means of electrical switching. Similar comments apply to the "cube diagonal."

Since the direction of arrival and polarization of sky waves varies continuously, fast pattern and polarization changes can be a help for receiving. Such flexibility is not available in mechanically steered antennas. Since the arriving wave is generally linearly polarized it helps to have a receiving antenna that can be switched to circular polarization also. This can reduce fading markedly and does not require constant attention.

For transmitting purposes the problem is entirely different. Assuming the optimum sky path and expected polarization is not known in advance (which is generally the case), all that one can do is transmit under antenna conditions that yielded the strongest signal on reception. If polarization changes during the transmission there is no signal or feedback. Since polarization changes quite rapidly with skywaves there is little advantage for these antennas from a transmitting point of view.

For long distance work, on the average, the antenna that can put the most power into a given direction with the lowest possible angle will get through most often. There will always be "freak" propagation conditions where almost any kind of antenna can produce the strongest signal. Such things as "one directional" skip do certainly exist although they are extremely rare. Electro-magnetic path loss is usually identical at a given instant of time and polarization, in the two different directions.

Peter Laakmann, WB6IOM

The box diagonal improved the "anti-fading" factor and the "DX in poor conditions" factor over the doublet, with similar feeders and tuners. These were delightful results of using more hardware.

If you are receiving my waves, which started on a triple polarization, instead of linear polarization, can you obtain as deep a fade on my signal? You may have thereby explained the reports I receive about less fading. Incidentally, what disturbs some engineers is that I observe reports of less dissipation per hop on the one hand, and on the other, feel that these systems have no great receiving advantages. I believe that the propagation damage happens to different styled waves differently in the ionosphere, (which itself is of peculiar polarizations), and after that fact, no receiving antenna can restore that extra dissipation. This is why I ask for transmitting, instead of receiving, tests through the ionosphere.

The antenna that yielded the strongest signal on reception (at my contact's location) was not the dipole—it was one of my multivector systems. Apparently I radiate a bushel-basket wave and overcome fading by being every which way at once. In optics a polarized filter can null light of singular polarization but it cannot null multi-polarized light.

Carl Mosley, an antenna manufacturer, in a technical talk at the Rochester Hamfest, said that quads (which have low-grade two dimensional vectorship) open the bands about a half hour earlier and close them about a half hour later than equal gain Yagis (which have high-grade one-dimensional vectorship). I think he was referring to poor propagation conditions, such as at band openings and closings. The low-grade two-dimensional waves of quads were many dB better than Yagis, but this difference does not remain when propagation is excellent. I observed the same confounding peculiarity on my continuous-spectrum, high-grade, two dimensional system, and then improved the effect by going to several three-dimensional systems. Comparative transmitting results are so unbelievably good, on poor skip, that after you have a three-dimensional system working, you will

be called a liar by those who never have tried one. When your DX contact is weak, all you have to ask is, "How does my signal strength compare with other American signals which you can hear now?" I suggest that you keep your tape recorder handy.

George A. H. Bonadio, W2WLR

Dear HR:

Bill Orr's otherwise complete article on fm in the September issue glossed over one interesting point. This "footnote" is an effort to set the record straight.

Ham radio really missed the boat by not being the first service to pick up fm as an improvement over a-m. In the late 1930's, when fm was first suggested (magazines carried construction articles), putting an fm station on the air meant building a new kind of receiver (wide-band i-f, limiter and discriminator) and using it on either 5 or 2-1/2 meters. You can believe that no one was trampled in the rush, although a few brave souls did try it (and became believers).

In the next go-round, *narrow-band* fm was permitted on the more popular hf bands, but as Bill mentioned, it was used predominantly by hams trying to avoid bci (that's "broadcast-receiver interference" to the tv generation). Bill says that "... fm languished in the amateur bands ... (it) was obtained by the flood of surplus a-m gear that invaded the market." That's just nice-guy Orr letting the hams off lightly. Look at the record. In the late 1940's every ham had an a-m receiver. To receive an fm signal he had to use slope detection (tune off to one side of the carrier frequency); you could copy an fm signal that way, but in doing so the fm signal took a 6-dB loss.

"So what?" you ask. Well, if you were using a 100-watt fm transmitter, you started out by taking an immediate 6-dB back seat to every 100-watt a-m rig on the band. Quite an incentive to change from a-m to fm!

Oh, but surely the hams realized that fm was better than a-m, for the reasons set forth in the technical articles of the time. Don't you believe it! Hams reasoned that their receivers told the true story, regardless of what the magazine articles said.

They had observed a-m take out fm on their receivers; that was all the proof they needed.

Some manufacturers made fm detector/adapters that could be tied into an existing a-m receiver, to permit copy of an fm signal as it should be (and without the 6-dB disadvantage). But why invest in a gadget when your trusty station receiver had already proved that the *signal* (fm) was an inferior type? And thus, in 1939 and again in 1947, amateur radio booted a golden opportunity to grow up.

Then came ssb. On an a-m receiver it couldn't even be copied. But on a cw receiver (once you acquired the knack of tuning) sideband was loud and clear and had it all over a-m. And—here's the meat—every ham had an a-m/cw receiver. (How many—even now—have an a-m/fm receiver?) No ham had to buy anything to learn the superiority of sideband. Sure, he did have to learn how to use his receiver, but the little beauty was already paid for and all the owner needed was a few hits on the head and a little practice.

So we hams missed the boat by not picking up fm immediately, but we didn't boot sideband because our receivers could handle it. What do we do with the next great, or near-great, improvement that is offered to us?

Glad you asked. Here are a couple of suggestions:

1. Understand the new thing. If you don't, or think you can't, find someone you trust and ask him to explain it to you. But until you *understand* the new thing, don't form an opinion! (That 6-dB disadvantage of fm disappeared with a suitable receiver, as did the "horrible, impossible, incompatible splatter of ssb.")

2. Don't brag about how quick amateur radio is to pick up new technical improvements. As Bill pointed out in his article, information on fm has been available since 1935 or so. It is a fact that hams are beginning to use fm at an increasing rate toward the end of the 1960's. This is alacrity?

**Byron Goodman, W1DX
East Hartford, Connecticut**



Many thousands of you have become very familiar with the various Radio Society of Great Britain books and handbooks, but very few of you are familiar with their excellent magazine, **Radio Communication**.

This is the oldest and most widely

read British amateur radio magazine. Published monthly it provides complete coverage including such popular features as: Technical Topics, a monthly survey of the latest ideas and circuits, Four Meters and Down, a rundown of the latest in VHF and UHF and much more.

It includes numerous technical and construction articles in addition to a complete rundown on the month's events in amateur radio. Surely a most interesting addition to your amateur radio activities.

We can now offer this fine magazine to you along with the other advantages of membership in the RSGB (such as use of their outgoing QSL Bureau) for only \$6.00 a year.

book division

comtec

Box 592 • Amherst, New Hampshire 03031

FREQUENCY STANDARD

The pictured completely assembled and tested printed circuit Frequency Standard, is a must in every Ham station. If you now own a conventional 100KHz calibrator it is inadequate, out of date--but you can salvage your 100 KHz crystal and use it with our Model 100-5, or Model 100-25 Frequency Standard to get sharp, accurate markers to keep your receiver-transceiver exactly on frequency.

MODEL 100-25 HAS 3 OUTPUTS: 100, 50, AND 25 KHz.
PRICE \$12, LESS XTAL, POSTPAID.

MODEL 100-5 HAS 5 OUTPUTS: 100, 50, 25, 10 AND 5 KHz. PRICE \$15, LESS XTAL, POSTPAID.

SPECIFICATIONS:

1. ALL COMPONENTS ASSEMBLED AND TESTED.
2. GLASS EPOXY PC BOARD.
3. BUILT-IN TRIMMER ALLOWS PRECISE ZERO-BEATING TO WWV.
4. POWER REQUIRED-5VDC AT 130 MA.
5. OUTPUT- 3.8V SQUARE WAVE.
6. VERY COMPACT, ONLY 1.6 X 2.5 INCHES.

GUARANTEE - includes repair or replacement of either unit for 90 days.

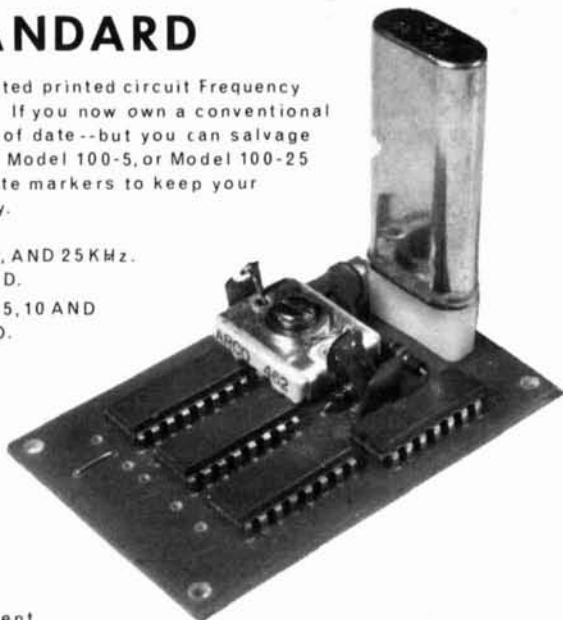

BAKER EX W3ZNI & WINNAY K3KRF
420 MAPLEWOOD AVE.
SPRINGFIELD, PA. 19064

new products

new linear amplifier



Gonset has just announced a new linear amplifier for the amateur high-frequency bands—the GSB-201 Mark IV. This new grounded-grid amplifier is capable of the maximum legal input of 2000 watts PEP on 10, 15, 20, 40 and 80 meters and uses four husky carbon-anode 572B's along with a reliable solid-state full-wave bridge power supply. Both the high-voltage and bias supplies are built into the unit. Also included in the package is a universal antenna change-over relay that permits using the amplifier with either a transceiver, or with an independent transmitter and receiver. The cooling fan operates only while transmitting. \$495 from your local dealer. Complete descriptive information is available from Gonset Division, Aerotron, Inc., P. O. Box 6527, Raleigh, North Carolina 27608.

electronic keyer



Curtis Electro Devices has announced a new IC electronic keyer that features dot memory and instant character start. Speed range is 8 to 50 wpm. In addition to providing perfectly formed and spaced characters, the unit will provide semi-automatic operation with a straight key or "bug." Power supply, sidetone oscillator and speaker are built in. Sidetone pitch and volume controls are provided as well as momentary and locked "tune" switches.

A jack is provided for an external manual stand-by key. Output keying is switch selected for either solid state (—105V, 50 mA maximum) or read relay (optional). Cover is light blue wrinkle finish, with panels in dark green to match the popular Heath SB series. Other popular color combinations are available on special order for a slight additional cost. Complete, less paddle, \$56.00; kit with assembled and tested card with connector, \$25.00; relay option is \$3.00 extra. Curtis Electro Devices, Box 4090, Mountain View, California 94040.

worthington phasar-40 antenna

The new Worthington Phasar-40 is an electronically steerable directional vertical antenna array for 40 and 15 meters. The antenna system consists of two self-support-



PHASE CORPORATION ELECTRONICS DIVISION

FOUR TRACE PRE-AMP KIT

ONLY
\$24.95

AUDIOPHILES
TECHNICIANS
HOBBYISTS
HAMS
TEACHERS
ENGINEERS
EXPERIMENTERS

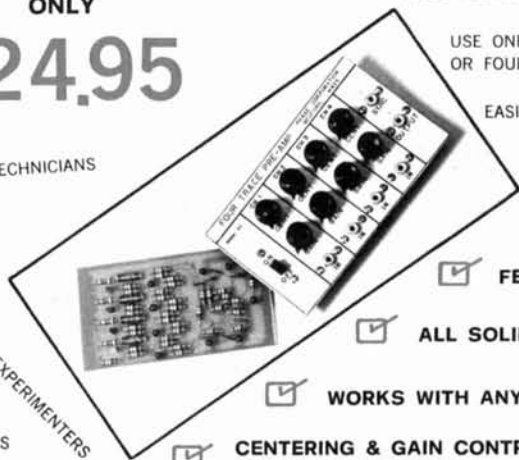

MAKES YOUR OSCILLOSCOPE
MORE FLEXIBLE

USE ONE, TWO, THREE
OR FOUR TRACES

EASILY ASSEMBLED

**CHECK
THESE
FEATURES**

FET INPUT

ALL SOLID STATE

WORKS WITH ANY SCOPE

**CENTERING & GAIN CONTROLS
FOR EACH CHANNEL**

SPECIFICATIONS:

BANDWIDTH: 1 MEGAHERTZ/CHANNEL

DISPLAY TIME: 50 μ SEC/CHANNEL

TRANSITION TIME: 5 μ SEC.

MAXIMUM OUTPUT VOLTS PER CHANNEL:

0.5 VOLTS PEAK TO PEAK

INPUT IMPED./CHANNEL: 1 MEG Ω

GAIN/CHANNEL: -20 db

KIT CONTAINS ALL PARTS, THIRTEEN TRANSISTORS (INCLUDING 4 FET'S), 2 DIODES, ALL TEMPLATES, ETCHED AND DRILLED CIRCUIT BOARD, AND COMPLETE EASY TO FOLLOW INSTRUCTIONS.

SYNC. OUTPUT PROVIDED

CAN BE BUILT INTO YOUR SCOPE, OR USED WITH THE OPTIONAL CUSTOM CABINET.

THE SENSITIVITY IS LIMITED ONLY BY THE SENSITIVITY OF YOUR OSCILLOSCOPE.

WORKS ON BATTERY VOLTAGE AS LOW AS 3V.

PORTABLE AND COMPACT

USES STANDARD 9V BATTERY (NOT SUPPLIED)

CAN BE USED AS A STAIRCASE GENERATOR WITH THREE VARIABLE LEVELS

MODEL A1K \$24.95

CUSTOM CABINET 4.98

ETCHED AND DRILLED CIRCUIT BOARD ONLY \$ 5.00

ASSEMBLED, COMPLETE WITH CUSTOM CABINET

MODEL A1W 49.95

THE PHASE CORPORATION, MEDFORD, MASS. 02155

Mass residents
add 3% sales tax

Gentlemen: Please send the following

Please print

Model A1K \$24.95

Name _____

Custom Cabinet 4.98

Street _____

Model A1W 49.95

City _____ State _____ Zip _____

Etched and Drilled
circuit board only 5.00

I enclose a check or money order in the amount of _____

Please charge this to my Master Charge # _____ BankAmericard # _____

ing quarter-wave radiators spaced either 34 or 68 feet. A remotely located control head allows selection of either a figure-eight or cardioid pattern. Rapid pattern switching allows the operator to null interfering amateur and foreign broadcast signals. The Phasar-40 provides a low angle of radiation for enhanced DX work. Properly installed, with an external ground system, the Phasar-40 will exhibit up to 4.5 dB over a single quarter-wave vertical, and up to 7 dB over a half-wave dipole.

Because of the relatively small diameter of the tube used for the vertical elements, the Phasar-40 is virtually invisible when viewed from any distance. Strength has not been compromised, however, and the antenna has been built to withstand 70 mph winds. \$89.95 from Worthingam Electronics Company, P. O. Box 507, Warren, Michigan 48090.

rsgb vhf manual

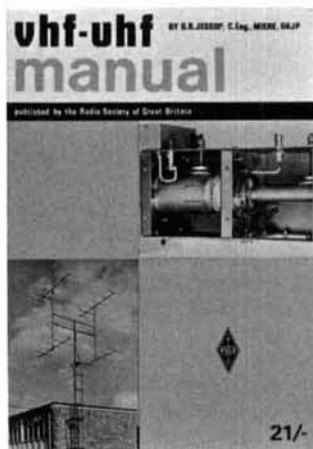

The Radio Society of Great Britain has published another excellent handbook for hams. It's the 245-page VHF-UHF Manual, written by G. R. Jessop, G6JP.

Perhaps the best way to point out its usefulness is to discuss the material it contains:

The first chapter is devoted to propagation, and should interest both the beginner and advanced vhf'er.

The chapter on tuned circuits and filters includes both design tables and formulas, and tested designs that are ready to copy. Of particular interest is the information on quarter-wave helical filters, which are little known, yet offer many advantages.

The chapter on receivers includes much general material, a complete hf/i-f receiver, an excellent discussion of noise, and many vacuum tube and semiconductor vhf/uhf converters and preamplifiers. One section of this chapter that will undoubtedly attract much attention is that devoted to tunnel diode amplifiers, including a practical 70-cm (432 MHz) preamp with a 3- to 4-dB noise figure. However, few would be likely to use one of these tricky beasts at 432 when easy-to-use fet circuits provide comparable performance.

Two 23-cm (1296 MHz) converters— one using transistors—and a unique crystal-controlled 13-cm (2304 MHz) converter are described. As is usually the case in RSGB publications, complete and detailed diagrams, layouts and tuning instructions make it easy to duplicate these converters.

The chapter on transmitters is as complete and interesting as that on receivers. Design information is provided on both tube and transistor equipment. Some descriptions that especially caught my eye were a true cavity 70-cm amplifier using a 4CX250, and simple 1/2-W, 2-meter and 70-cm solid-state transmitters that could be duplicated inexpensively in a few hours. Other chapters cover ssb, antennas and test equipment.

The fact that the book was written for English amateurs results in a few items of interest. The power limit is lower (150 W dc input), the popular band segments are slightly different (or in the case of 6 meters, quite different—they have 4 meters at 70 MHz), and some of the terms and components are unlike ours. However, these are minor and not liable to cause any problems. The RSGB *VHF-UHF Manual*, which is available for \$3.75 postpaid from Communications Technology, Box 592, Amherst, New Hampshire 03031, belongs in the shack of every amateur interested in vhf and uhf.

SPECTRONICS

The FM People

Our 5000 square foot, air conditioned building houses the greatest concentration of Motorola mobile gear and odds and ends available anywhere!

Once in the Chicago area, come out of the Loop, West on Congress and/or Eisenhower Expressway 1-90 to Harlem Ave. Ill. 43 (exit center rather than right) turn left or south about 100 feet, left again or east, about three short blocks.

If you still can't make it to our place then use the phone and call Art Housholder (K9TRG) and he will knock himself out to find what you need and get it shipped off to you.

To receive our current listings of Motorola equipment please write today. We sell to Amateurs only! All equipment sold as is F.O.B. Oak Park, Illinois.



PT300



HT200



XMITTER BOARDS ONLY JUST ARRIVED, NEW BATCH OF THE FOLLOWING:

FIRST COME FIRST SERVED

\$50.00 each

SOME 2 FREQ. — SOME W/PL CIRCUITRY

SOME 136-150.8 — SOME 150.8-170

SOME TO DRIVE THE PT-AMP

SOME PT AMPLIFIERS AVAILABLE

NTD 6031 AA
6052 AA-B&C
6071 AB&AA
6073 AC&AA
6082 AA
6083 AD
6092 AC&AA
6093 AA&AD
6102 AA
6103 AA&A
6113 A&AA

SPECTRONICS, INC.

The FM People

1009 Garfield St. • Oak Park, Ill. 60304

Phone: Area Code 312-848-6778

Closed Sundays, Mondays and Holidays

hot-carrier diodes

Motorola Semiconductor recently announced a hot-carrier diode designed primarily for uhf mixer and detector applications, but also suitable for fast switching circuits. The new hot-carrier diode, MBD101, is supplied in an inexpensive plastic package and sells for \$.89 cents each in small quantities. The new MBD101 features low noise figure—7 dB maximum at 1 GHz, as well as very low capacitance and high forward conductance. This new diode should be very interesting to amateurs who would like to try hot-carrier diodes but have been unable to obtain suitable devices.

The Hewlett-Packard type 2800 hot-carrier diodes are now available for 90¢ each post-paid from H A L Devices, Box 365, Urbana, Illinois 61801. These are the diodes used in the three hot-carrier diode projects in the October 1969 issue of *ham radio*.

low-cost lasers

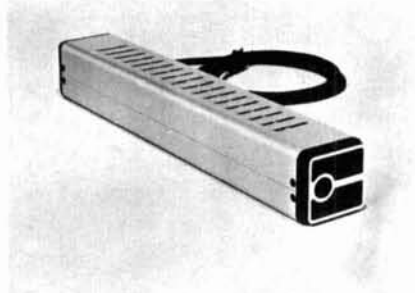

If you're interested in trying your hand at laser communications, holography, interferometry or spectroscopy, suitable lasers are now available at very reasonable prices. The model 301 helium-neon gas laser from Quantum Physics, Inc., for example, is available in kit form or fully assembled. This laser produces 1 mW of uniphase radiation in the red-orange portion of the optical spectrum. The model 301 features a long-life cold-cathode plasma tube with an integral mirror mounter and integral power supply.

While the 1mW output power is considered well below the safe range, this laser is not a toy, but a sophisticated instrument that is suitable for many laser experiments. Because the laser chassis and power supply

are prefabricated, the kit, which includes a prealigned laser tube and all mounting hardware, can easily be assembled in a few hours. Complete kit is \$170; professionally assembled, \$225. Larger 3 mW and 10 mW gas lasers available. Quantum Physics, Inc., 1295 Forgewood Avenue, Sunnyvale, California 94086.



Another entry into the low-cost laser market is the 0.5 mW Metrologic model 310, which was designed with the experimenter in mind. The model 310 operates in the orange-red portion of the visible spectrum, and emits about 0.5mW with a mean divergence of 0.5 milliradian. This instrument is ruggedly built and easy to take apart and reassemble. The price of the model 310 is \$99.50. For more information, write to Metrologic Instruments, Inc., 140 Harding Avenue, Bellmawr, New Jersey 08030.

low-resistance measurements

A new low-cost meter attachment capable of converting the Amphenol Millivolt Commander (and other 10-ohm centerscale meters) into a low-range ohmmeter has been announced. This new accessory is especially valuable for checking low value dropping resistors in solid-state supplies as well as for testing transformerless transistorized audio power amplifiers where the output resistance is typically in the 0.4- to 0.6-ohm range. The current is limited to 100 mA across 1 ohm, so the device under test is fully protected against accidental burnout. Price of the new Amphenol 870-3 milliohm meter attachment is \$14.95. For more information, write to Amphenol Distributor Division, 2875 S. 25th Avenue, Broadview, Illinois 60153.

FM**FM****FM****Sales to Licensed Amateurs Only****MOTOROLA 60 WATT FOUR CHANNEL
150MC MOBILES**

MODEL T53-GJV 6/12 volt. These units are exceptionally clean and in mint condition. They are complete with 4 freq. control head, cables, mike, speaker. Xmtr - narrow band, rcvr is wide band. Less crystal ovens & ant.
Only \$175.00 ea.

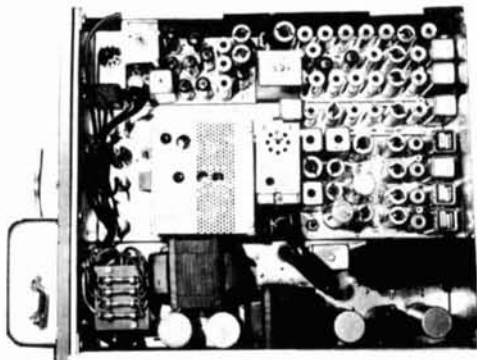
**T53-GJV**

G.E. PROGRESS LINE - 150 mc - 60 WATT - FOUR FREQUENCY - MA/E-36. These are also very clean and in mint condition. Complete with all access., less crystals & ant.

\$225.00 ea.

MOTOROLA 150 mc transistorized pocket pager receiver. HO3ANC-1102AQ. Excellent cond., less battery. **\$34.95 ea.**

MOTOROLA "HT" series Handi-Talkies. 150MC. Prices vary according to model: standard, universal, 1 freq., 2 freq., P.L., etc.



G.E. PROG. LINE, 30-54MC, 6/12 volt, 60 watt. Complete with all accessories (less Ant). Single freq. **\$100.00 ea.**, Dual freq. **\$110.00 ea.**, Four freq., **\$130.00 ea.**

DIGITAL DECODER, Secode RPD 634.**\$19.95 ea.**

MOTOROLA Handi-Talkies, 150mc, 1 watt out, fully transistorized rcvr, checked out & operating. W/nicad battery. H23BAM.

\$69.50 ea.

NICAD batterys for "HT" series Handi-Talkies, NLN 6238, untested \$3.00 ea.
Nicads for H11, H13 pocket transmitters, NLN 6117A \$4.95 pr.

MOTOROLA MOBILE TELEPHONE test set TEK22, (list price-\$550.00) like new.

\$180.00 ea.

MOTOROLA 150 mc Handi-Talkies, guaranteed operating, less mike & batteries.

FPTRUL \$19.95 ea.

MOTOROLA CHARGER for H11, H13 pocket xmtrs, NLN6121A.

\$9.95 ea.

MOTOROLA 150 mc receiver strips, very clean, 6v \$25.00 ea.

30 Watt xmtr strips, 6v \$20.00 ea.

MOTOROLA transistorized "Big Voice" power speakers \$19.95 ea.

MOTOROLA power supply, NPN 6023A for P31, P33BAC, L/batteries \$4.95 ea.

**SATISFACTION GUARANTEED OR YOUR MONEY BACK!**

All equipment unless stated otherwise is complete and guaranteed. Items over 20 pounds shipped freight charges collect. Include sufficient postage for other items. 25% deposit required on c.o.d. orders. Michigan residents add 4% sales tax. We have a very large stock of FM equipment, however no catalogs or list available. Tell us what you are looking for, we may have it. Prices subject to change without notice.

NEWSOME ELECTRONICS

hours: by appointment only

19673 ALLEN ROAD • TRENTON, MICHIGAN 48183

PHONE: 313-282-6464

Stellar

NEEDS USED GEAR

Top trade in allowances on all major brands of ham equipment.

10 GRAHAM ROAD WEST • ITHACA, N. Y. 14850
TELEPHONE AREA CODE 607-257-2424

Subscription rates US \$3.50 (\$4.50 air mail) per calendar year. Single issues \$1.10.

radio amateur callbook

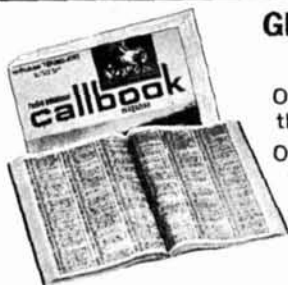

GET YOUR NEW ISSUES NOW!

Over 290,000 QTHs in the U.S. edition **\$7.95**

Over 140,000 QTHs in the DX edition **\$5.95**

NEW EDITION EVERY:
MARCH 1 — SEPT. 1
JUNE 1 — DEC. 1

These valuable EXTRA features included in both editions!

- QSL Managers Around the World!
- Census of Radio Amateurs throughout the world!
- Radio Amateurs' License Class!
- World Prefix Map!
- International Radio Amateur Prefixes
- Radio Amateurs' Prefixes by Countries!
- A.R.R.L. Phonetic Alphabet!
- Where To Buy!
- Great Circle Bearings!
- International Postal Information!
- Plus much more!

See your favorite dealer or order direct (add 25¢ for mailing in U.S., Possessions & Canada. Elsewhere add 50¢).

WRITE FOR FREE BROCHURE!



RADIO AMATEUR
callbook INC.

Dept. E. 925 Sherwood Drive
Lake Bluff, Ill. 60044

GEM-QUAD FIBRE — GLASS

ANTENNA FOR 10, 15, and 20 METERS.

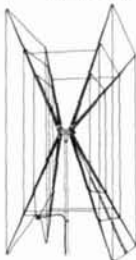

Two Elements \$77.73
Extra Elements \$45.00 ea.
Shipped Freight Collect
INCLUDES U.S. Customs Duty

- KIT COMPLETE WITH**
- SPIDER
 - ARMS
 - WIRE
 - BALUN KIT
 - BOOM WHERE NEEDED

SEE OUR FULL PAGE IN JUNE ISSUE

Buy two elements now — a third and fourth may be added later with little effort.

Enjoy optimum forward gain on DX, with a maximum back to front ratio and excellent side discrimination.

Get a maximum structural strength with low weight, using our "Tridetic" arms.



MANITOBA DESIGN INSTITUTE
AWARD WINNER

Structural Glass
LIMITED

20 Burnett Avenue, Winnipeg 16, Manitoba, Canada

flea market



■ **RATES** Commercial Ads 25¢ per word; non-commercial ads 10¢ per word payable in advance. No cash discounts or agency commissions allowed.

■ **COPY** No special layout or arrangements available. Material should be typewritten or clearly printed and must include full name and address. We reserve the right to reject unsuitable copy. **Ham Radio** can not check out each advertiser and thus cannot be held responsible for claims made. Liability for correctness of material limited to corrected ad in next available issue. Deadline is 15th of second preceding month.

■ **SEND MATERIAL TO:** Flea Market, Ham Radio, Greenville, N. H. 03048.

NEW JERSEY'S largest Ham auction Friday, April 3, 1970, sponsored by the Key Klackers of Stirling. Watch for further details.

1916 QST'S wanted. Especially May and June. Any unreasonable price paid! Ted Dames, W2KUW, 308 Hickory Street, Arlington, N. J. 07032.

SAROC: new QTH Stardust Hotel, new QTR February 4-8, 1970. Cocktail parties hosted by **Ham Radio Magazine**, **Swan** and **Galaxy**. For additional information and Stardust Hotel special SAROC room rate card QSP SASE SAROC, Box 73, Boulder City, NV 89005.

ANNUAL ST. PATRICK'S DAY SWAPFEST. Midland Amateur Radio Club, March 14th and 15th. Write MARC, Box 967, Midland, Texas 79701 for details.

THE EAST COAST VHF Societies annual Dinner will be held Saturday, March 21, 1970, at the Neptune Inn, Route 4, Paramus, N. J., at 7:00 p.m. W4FJ, Ted Mathewson will talk on "VHF - Past, Present, and Future". Awards will be given by W1HDQ, Ed Tilton, including awards for highest single and multi-operator station in the September VHF contest. Menu will be Prime Ribs of Beef and tickets are \$7.50. Group reservations available in blocks of 5 to 10. Ticket deadline is Wednesday, March 11th. Write the East Coast VHF Society (WA2WEB), P. O. Box 1263, Paterson, N. J. 07509.

DO YOU KNOW about the RSGB? See page 75.

SAVE. On all makes of new and used equipment. Write or call Bob Grimes, 89 Aspen Road, Swampscott, Massachusetts, 617-598-2530 for the gear u want at the prices u want to pay.

NORTHERN CALIFORNIA Hams: Best deals — new and reconditioned equipment. Write or stop for free estimate. The Wireless Shop, 1305 Tennessee, Vallejo, California 94590.

LIKE WASHINGTON we can't tell a lie. You'll have a ball at the ARRL Hudson Division Convention, October 17-18, Hilton Motor Inn, Tarrytown, N. Y. Exhibits, Lectures, Contests, Gabfests, New York Sightseeing, Fun. Honest! Hudson Amateur Radio Council, Box 58, Central Islip, N. Y. 11722 has all the dope.

WORLD RADIO has used gear with trial-guarantee-terms! 99'er - \$79.95; 910A - \$179.95; SR150 - \$299.95; HW10 - \$129.95; HW32 - \$89.95; Swan 400/420 - \$299.95; Swan 250 - \$229.95; DuoBander 84 - \$109.95; 753 - \$129.95; NC200 - \$249.95; SB33 - \$199.95; Galaxy Vmk2 - \$279.95; Ranger 2 - \$149.95; 200V - \$399.95. Free "blue-book" list for more. Write WORLD RADIO, 3415 West Broadway, Council Bluffs, Iowa 51501.

TUBES — Lowest World price. Foreign-American. Obsolete, current. Receiving, Special Purpose, Transmitting tubes. Send for tube and parts catalog. United Radio Company, 56-HR Ferry Street, Newark, New Jersey 07105.

23rd ANNUAL LAWTON-FORT-SILL A.R.C. Hamfest will be held on Sunday, February 22, 1970 at the Lawton National Guard Armory. For more information and reservations write the club at its P. O. Box 892, Lawton, Oklahoma 73501.

ROCHESTER, N. Y. is again Hamfest. VHF meet and flea market headquarters for largest event in northeast, May 16, 1970. Write WNY Hamfest, P. O. Box 1388, Rochester, N. Y. 14603.

NEW RULES for the ECVHF Society Inc. Certificate (Achievement) Award for working Members of the Club. Work Club Station WA2WEB plus four Members, or work Five Members on any one Band 50 MHz and above. Send list to: George Kupp, 61 Cortlandt Street, Belleville, N. J. 07109. NO CHARGE. For Membership list send S.A.S.E.

HOT CARRIER DIODES. New HP 2800, 90¢, 12/\$10 pp. H A L Devices, Box 365H, Urbana, Illinois 61801.

FOR SALE: FACTORY SEALED: 30L-1, 312B-4, 312B-5, 516F-2, 75S3-B; 10% off (no trades). 30L-1, \$385. Waters #334 dummy load/wattmeter, \$70. R-390-A, cabinet \$750. HW-12-A, Drake Filter, Mike, HP-13, \$125. Eldico SSB-100-F Exciter, \$250; SSB-1000-F Linear with new spare 4CX-300-A's, \$250. KWM-2, PM-2, \$775. R4-A (factory up-dated 9/69), in factory-sealed carton, \$325. MN-2000, \$145. DC-3, \$75. R4-B, T4X-B, AC-4, MS-4, \$695. Waters "Codax" Keyer, \$50. Waters #3002 Hybrid Coupler, \$50. Johnson #250-20 Filter, \$9. KWM-1, 516F-1, \$225. Bird wattmeter, model 693, \$100. Stancor P-6468 (5VCT/30 amps), \$9. P-6309 (6.3VCT/20 amps), \$8. P-3060 (2.5VCT/10 amps, 10 KV ins), \$4. Power supply (UTC "CG" components), 115/220 input, 2500 VDC @ 400 MA output, \$35. HA-1 Keyer and Vibrokeyer, \$70. Vibroplex Keyer, \$10. P&H LA-500-M "Spitfire" Linear, new, \$75. Comdel CSP-11, \$75. SB-200/new spare T-160-L's \$200. KW Match-box with meter/indicator, \$135. KWM-2 #15750, 516F-2, (very latest!), \$875. Transformer, 115/220 input; 12/24V @ 60/30 amps. These are FB for building P. S. around Leece-Neville alternator (to run 1 K. W. Mobile), 3/\$50. James W. Craig, W1FBG, 29 Sherburne Avenue, Portsmouth, New Hampshire 03801.

THE 3rd ANNUAL BLOSSOMLAND Amateur Radio Auction will be held Sunday, March 15, 1970 at the Youth Memorial Building, Berrien County Fairgrounds, one mile northwest of beautiful downtown Berrien Springs, Michigan. Free parking, hot food, prizes, swap tables.

INTEGRATED CIRCUITS: New Fairchild Micrologic, epoxy TO-5 package. 900 buffer, 914 gate, 60¢ each. 923 J-K flip-flop, 90¢ each. Guaranteed Add 15¢ postage. H A L Devices, Box 365H, Urbana, Illinois 61801.

8th ANNUAL WCRA MIDWINTER HAMFEST February 15, 1970 at Du Page County Fair Grounds, Manchester Road, Wheaton, Illinois. Open 9:00 a.m. to 4:00 p.m. Tickets \$1.50 at the Door. Some space available for your own table. For further information write, P. O. Box QSL, Wheaton, Illinois.

GREENE DIPOLE CENTER INSULATOR . . . see ad page 96, September 1969 Ham Radio.

TAKE YOUR PICK

These units will replace the 100 kHz calibrator built into most receivers. Using your 100 kHz crystal this unit will provide sharp accurate markers with readouts at 100 - 50 - 25 - 10 and 5 kHz usable thru 50 MHz. Keep your receiver calibrated at all times, locate sub bands, MARS frequencies and band edges.



OR



Frequency marker, less cabinet and switch

Specifications: Glass Epoxy Board. Adjustment to zero beat with WWV. Uses 100 KHz crystal (not supplied). 3 to 4 VDC. Compact — 1.75 x 3.75 inches. Install anywhere!

Complete easy-to-assemble kit \$16.50 Wired and Tested \$19.95

SWITCH \$1.00 CRYSTAL \$3.50
with purchase of any of above

SELF-CONTAINED UNIT

The TBL 1 Marker is a complete unit including the circuit board shown at left and powered with 3 "C" type flashlight batteries. Merely connect to your receiver antenna — no internal wiring necessary. A front panel control allows zero beat with WWV.

Special introductory price \$29.95
Less crystal and batteries
POSTPAID U.S.A.

SOLD WITH MONEY BACK GUARANTEE

THE RADIO SHOP, LAB 1

48 ELM STREET, NEW CANAAN, CONN. 06840 — Tel. 203-966-3553



Radio Amateurs
Reference Library
of Maps and Atlas

WORLD PREFIX MAP — Full color, 40" x 28", shows prefixes on each country . . . DX zones, time zones, cities, cross referenced tables . . . postpaid \$1.00

RADIO AMATEURS GREAT CIRCLE CHART OF THE WORLD — from the center of the United States! Full color, 30" x 25", listing Great Circle bearings in degrees for six major U.S. cities; Boston, Washington, D.C., Miami, Seattle, San Francisco & Los Angeles. . . . postpaid \$1.00

RADIO AMATEURS MAP OF NORTH AMERICA! Full color, 30" x 25" — includes Central America and the Caribbean to the equator, showing call areas, zone boundaries, prefixes and time zones, FCC frequency chart, plus informative information on each of the 50 United States and other Countries. . . . postpaid \$1.00

WORLD ATLAS — Only atlas compiled for radio amateurs. Packed with world-wide information — includes 11 maps, in 4 colors with zone boundaries and country prefixes on each map. Also includes a polar projection map of the world plus a map of the Antarctica — a complete set of maps of the world. 20 pages, size 8 3/4" x 12" postpaid \$2.00

Complete reference library of maps — set of 4 as listed above postpaid \$3.00
See your favorite dealer or order direct.

WRITE FOR FREE BROCHURE!
RADIO AMATEUR callbook INC.
Dept. E, 925 Sherwood Drive
Lake Bluff, Ill. 60044

SPACE AGE KEYS

Only
\$67.50



- Planar epitaxial integrated circuits for reliability. No tubes—No separate transistors.
- Precision feather-touch key built-in.
- Fully digital—Dot-dash ratio always perfect.
- No polarity problems—Floating contacts switch $\pm 300\text{-V}$ @ 100-ma.
- Rugged solid construction—will not walk.
- Send QSL or postcard for free brochure.

PALOMAR ENGINEERS

BOX 455, ESCONDIDO, CAL. 92025

MANITOGA CENTENNIAL AWARD 1870 - 1970. The Amateur Radio League of Manitoba will present certificate awards to amateurs submitting proof of the requisite contacts with Amateur Radio Stations in Manitoba. **RULES:** Contacts must be after December 31st, 1969. Contestants must accumulate 100 points. W/K, XE and VE stations receive two points per contact. Other stations five points per contact. A contact consists of exchanging signal reports. Contacts may be made on each band. Cross-mode contacts not allowed. Two members of the Amateur Radio League of Manitoba will be designated "Bonus Hams" each month. Contacts with them will be worth double points. Contestants should send a copy of their log and two I.R.C. to: Mr. J. N. Knowles, VE4JK, P. O. Box 365, Carman, Manitoba, Canada.

INDIANA. The Lake County Amateur Radio Club, Inc., announces its 17th Annual Banquet to be held at Teibel's Restaurant, U. S. 30 and 41 (near Schererville, Ind.) at 6:30 p.m., CST, February 14, Chicken dinner, entertainment, speeches. Come with your wife or girl friend. Tickets \$5.00 each from Herbert S. Brier, W9EGQ, 385 Johnson Street, Gary, Indiana 46402. Positively no tickets sold at the door.

SWAN 250 with 117XC AC supply, VOX unit, 100 kc calibrator \$325. 6M. Gonset sidwinder 910B with AC supply \$250. Gonset COMM III 6 meters \$130. Gonset COMM IV 6 meters \$155. Gonset VHF VFO #3357 \$50. Heathkit HR-10B ham band rcvr. \$60. Globe King 500A (4 ft rack) 500 watt AM & CW xmtr. \$150. Globe DSB 100 \$35. Hallicrafters gen. coverage rcvr. SX71 \$90. Hallicrafters military R-44/ARR-S rcvr. 28-146 megs with AC supply \$75. All equipment is in mint condition and works excellent. You pay shipping. Tom Dittrich, WB2LZD, 249 Meadow Lane, Vestal, New York 13850.

NOVICE CRYSTALS: 40-15M \$1.33, 80M \$1.83. Free flyer. Nat Stinnette Electronics, Umatilla, Fla. 32784.

HAMMARLUND SUPER-PRO BC-779-B in working order. Rack mounting model less cabinet. Includes power supply. Covers 200-400 kc, 2.5 to 20 mc. Only \$75. Hallicrafters S-40B & S-20R receivers both in good condition. S-40B \$40; S-20R \$25. All prices fob my shack. W1DHZ, Box 185, Amherst, N. H. 03031. Phone 603-673-4885.

HW32, latest factory modification; mike, mounting bracket. Hustler 20M coil section \$90. HP23, \$40. GE transistorized mobile supply for FM transceiver. Real buy at \$40. Budd Meyer, 10510 65th Avenue, Forest Hills, N. Y. 11375.

MOTOROLA 450 MHz BRICK'S. H24 DCN's two fq. xmtr. & rcvr. working 184.50. H23 DEN'S HT200 low range 132 to 150 Mhz 199.50. Topeka FM Engineering, 3501 Croco Road, Topeka, Kansas 66605. 913 266-8771.

HALLICRAFTERS SX-110, excellent condition. Best offer. Raymond Martin, Greenville, N. H. 03048. Phone 603-878-2758.

TOROIDS. 88 or 44 mhy., center tapped, not potted, 5/\$2.00 POSTPAID. NOTE!! 40/\$10.00 POSTPAID. Model 32KSR page printer on pedestal, complete 60 or 100 speed printer, little used . . . \$200. FRXD10 typing reperferator with TD on same base \$25. Model 19 set \$95. Model 14TD sync motor \$18. MXD three head TD \$35. Tape winder \$6. Oiled reperferator tape \$3/box/10 or \$10/case/40 rolls. FACSIMILE paper (12" x 19") 250 sheet package \$4. Double squirrel cage blower (110VAC 60 cycle) silent type \$5. RCA CV57/URR terminal unit \$85. New Clegg 66er transceiver \$150. WANTED: Ham M rotor. Stamp for list. Van, W2DLT, 302H Passaic Avenue, Stirling, N. J. 07980.

HALLICRAFTERS SR400 transceiver, HA20 DX adapter (outboard vfo with swr meter), P500 ac power supply, 1 1/2 years old, mint condition, \$800. Used as second station, never mobile, must sell. Box C, Ham Radio, Greenville, N. H. 03048, or call (617)762-5863.

CHICAGO Suburban Radio Association annual Ham-boree on March 22nd at East Avenue and 55th Street, Countryside, (La Grange), Illinois. Flea Market and prizes. For further information contact Wilson Thomas, W9KWA, 4017 Vernon Ave., Brookfield, Ill. 60513. Phone: (312) HU 5-0451.

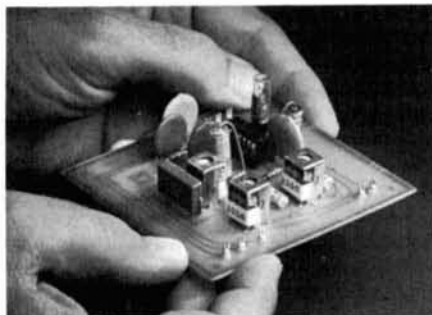

IC Stereo Decoder Uses Miller High Q Coils

A monolithic integrated FM stereo decoder system developed by Motorola provides excellent channel separation, good ultrasonic rejection and low THD content at the output.

Write for 6-page "Coil Forum" construction article.



J.W. MILLER COMPANY
19070 Reyes Ave. • P.O. Box 5825
Compton, California 90224

AVAILABLE NATIONWIDE FROM DISTRIBUTORS

**NEW
from
NRI**

Home training in AMATEUR RADIO

NRI, leader in Communications, Television, Electronics and TV-Radio home training, now offers the first in Amateur Radio courses, designed to prepare you for the FCC Amateur License you want or need.

Don't lose your favorite frequency

The FCC has said "either-or" on licensing, but to pass Advanced and Extra Class exams, you need the technical guidance as offered by NRI. NRI Advanced Amateur Radio is for the ham who already has a General, Conditional or Tech Class ticket. Basic Amateur Radio is for the beginner and includes transmitter, 3-band receiver, code practice equipment. Three training plans offered. Get all the facts. Mail coupon. No obligation. No salesman will call on you. NATIONAL RADIO INSTITUTE, Washington, D.C. 20016.



MAIL NOW

• NATIONAL RADIO INSTITUTE 46-020 •
 • Washington, D.C. 20016 •
 • Please send me information on Amateur Radio •
 • training. •
 • Name _____ Age _____ •
 • Address _____ •
 • City _____ State _____ Zip _____ •
 • ACCREDITED MEMBER NATIONAL HOME STUDY COUNCIL •

what's

NEW

on 2?

PROTECTED DUAL GATE MOSFET PREAMP

- protected from RF overload and static discharge
- virtually indestructible — more than 18 db gain
- less than 3 db noise figure — 144 to 148 MHz
- 6V. to 15V. dc — add \$0.50 for other frequencies

HF-144DGK kit net \$9.50 HF-144DGW wired net \$14.50

ALSO AVAILABLE FOR MOTOROLA MOTRACS

- same specs as above — complete with all hardware and RF jumpers
- wired only

HF-144ML	144 to 148 MHz	net \$15.50	list
HF-144MM	148 to 160 MHz	\$16.50	\$22.50
HF-144MH	160 to 174 MHz	\$16.50	\$22.50

SINGLE GATE MOSFET PREAMP

- less than 3 db noise figure — 17 db gain

HF-144K kit net \$6.50 HF-144W wired net \$10.95

HF-144PK receiver B+ to 12V. dc \$1.25

PLEASE INCLUDE \$0.60 FOR SHIPPING — 1 to 3 ITEMS

Topeka FM Engineering

3501 Croco Road

Topeka, Kansas 66605

913 266-8771

NEED CRYSTALS?



48 Hr. DELIVERY

We can supply crystals from 2KHz to 80 MHz in many types of holders.

SPECIALS

Color TV crystal (3579, 545KHz) wire leads	\$1.60	4 for \$5.00
100KHz freq. std. crystal (HC13/U)	4.50	
1000 KHz freq. std. crystal (HC6/U)	3.50	
Any CB crystal TR. or REC.	2.25	
Any amateur band crystal (except 80 meters) in FT-243 holders	1.50	4 for \$5.00
Any marine frequency (HC6/U)	2.85	
80 meter — FT-243 holders	2.50	

We have in stock over six million crystals which include types CR1A/AR, FT243, FT241, MC7, FT249, HC6/U, HC13/U, HC25/U, HC18/U, etc. Send 10¢ for our 1970 catalog with oscillator circuits, listing thousands of frequencies in stock for immediate delivery. (Add 10¢ per crystal to above prices for shipment 1st class mail, 15¢ each for air mail).



Special Quantity Prices to Jobbers and Dealers.

ORDER DIRECT with check or money order to

2400 Crystal Drive
Fort Myers, Florida 33901

HAL DEVICES



HAL 311B
IC KEYER
\$43.50 pp

Incorporating all of the features of the HAL IC keyer line, the 311B is the most versatile keyer now available. The 311B offers

- Transistorized output circuit for both grid block and cathode keyed transmitters. Up to 150 v, 500 ma.
- Keyed pulse generator, speed 8-50 wpm.
- Transmitter tune-up switch
- Connection point for straight key
- Rugged G10 glass PC board construction
- Iambic operation for squeeze keying
- Dot memory
- Automatic or semi-automatic operation
- Monitor with tone and volume controls
- Regulated 115 VAC power supply
- Connection point for 3VDC source
- Beige and Walnut grain Designer Cabinet

HAL Devices
P.O. Box 365 H
Urbana, Ill. 61801

Other models available from \$16.00. Write for details and our listing of other products.

WORLD QSL BUREAU — see ad page 89.

TR-4, AC SUPPLY. Best offer. Hand deliver Ohio or adjacent states. Gordon Wolford, WB8CKP, 318 South Adams, New Carlisle, Ohio 45344.

WANTED: Complete construction manual for Heath OP-1 Scope. Manual Collins 51M2 VHF receiver. Gil Barber, Box 3876, No. Las Vegas, Nevada 89030.

ORIGINAL EZ-IN DOUBLE HOLDERS display 20 cards in plastic, 3 for \$1.00, 10 for \$3.00 prepaid. Guaranteed. Patented. Free sample to dealers. Tepabco, John K4NMT, Box 198R, Gallatin, Tennessee 37066.

POLICE — FIRE — AIRCRAFT — MARINE Calls on your broadcast radio with TUNAVERTER S1 Tunable — Crystal! Brochure. Salch Company, Woodsboro HMC, Texas 78393.

HELP. I need a good used Collins 310B Exciter, National FB7 or FB7-X and a National SW-3. All letters answered via air mail. Jock White, ZL2GX, 152 Lytton Road, Gisborne, New Zealand.

75S3B, LATEST MODEL, with 500Hz filter, \$525. 32S1, mint, \$375. 51F2 ac supply, \$100. Drake L4 linear, \$475. Comdel CSP-11, \$80. Heathkit SB-610 monitorscope, \$65. Drake W4 swr/wattmeter, \$35. Eico 717 electronic key with Brown Bros paddle, \$40. 200-ft. new RG-17A/U with type-N connectors, \$50. 80-ft. guyed Rohn Tower, you take it down, \$50. Cushcraft 3el 20M beam, \$50; 4el 15M beam, \$50; 4el 10M beam, \$35; I'll help take down. Ham-M rotator, \$60. Fisk, Box 25, Rindge, N. H. 03461. (603) 899-5483.

GE AC SUPPLY — Prog Line, 60 watt, 4EP2F1 or similar, Ken Booher, K8JWC, 1421 Williamsburg Rd., Flint, Michigan 48507.

TOUCHTONE DIAL equivalent from Denmark. Ten buttons, convertible to all twelve in a minute with data included. Beige, except green and white while they last. 12VDC required for oscillator operation. \$15.00 postpaid USA. W6GDD, 6606-5th Street, Rio Linda, California 95673.

MOTOROLA HI-BAND UNITS — 117VAC, 30 watt — have Sensicon Receiver — complete — excellent condition — \$85. Have extra 117VAC power supplies and xmtr. strips. Write for details. Bob Clark, 2023 Fair Park, Little Rock, Arkansas 72204.

FOR SALE: MOTOROLA T44AA UHF 12 volt \$35.00. Hallicrafters HT-22 \$20.00. BC-224 radio \$60.00. Slims Radio, 2025 Sunkist, Waukesha, Wisconsin 53186.

TOROIDS 44 and 88 mhy. Unpotted. 5 for \$1.50 ppd. W. Weinschenker, Box 353, Irwin, Pa. 15642.

QSL'S — BROWNIE W3CJ1 — 3111-B Lehigh, Allentown, Pa. 18103. Samples 10¢. Cut catalogue 25¢.

QSLs. SECOND TO NONE. Same day service. Samples airmailed 25¢. Ray, K7HLR, Box 331, Clearfield, Utah 84015.

RAGS HAMFEST, Syracuse, New York, April 12, 1970 at Song Mountain. Box 88. Liverpool, New York 13088.

DAYTON HAMVENTION April 25, 1970: Sponsored by Dayton Amateur Radio Association for the 19th year. Technical sessions, exhibits and hidden transmitter hunt. An interesting ladies program for XYL. For information watch ads or write Dayton Hamvention, Dept. H, Box 44, Dayton, Ohio 45401.

DEALERS AMATEUR-CB. Now is the opportunity for you to make money selling new full warranty major line equipment and accessories. Send letterhead for list c/o Robert Weaver, WA5UUK, Madison Electronics, 1508 McKinney, Houston, Texas 77002. (713) 224-2668.

WANTED: Old copies of R9 magazine for private collection. W1DTY, Box 25, Rindge, N. H. 03461.

YOUR AD belongs here too. Commercial ads 25¢ per word. Non-commercial ads 10¢ per word. Commercial advertisers write for special discounts for standing ads not changed each month.

... THE BEST 2 METER CONVERTER



Model 407
\$39.95
ppd.

144-146 MHz in. 28-30 MHz out
or 146-148 MHz with a second crystal
available for \$4.95 extra

A full description of this fantastic converter would fill this page, but you can take our word for it (or those of hundreds of satisfied users) that it's the best. The reason is simple — we use three RCA dual gate MOSFETs, one bipolar, and 3 diodes in the best circuit ever. Still not convinced? Then send for our free catalog and get the full description, plus photos and even the schematic.

Can't wait? Then send us a postal money order for \$34.95 and we'll rush the 407 out to you. NOTE: The Model 407 is also available in any frequency combination up to 450 MHz (some at higher prices) as listed in our catalog. New York City and State residents add local sales tax.

VANGUARD LABS

Dept. R, 196-23 Jamaica Ave., Hollis, N.Y. 11423

TOROID CORES

Red "E" Cores—500 kHz
to 30 MHz— $\mu = 10$

#	OD	ID	H	EACH
T-200-2	2.00"	1.25"	.55"	\$3.00
T-94-2	.94	.56	.31	.75
T-80-2	.80	.50	.25	.60
T-68-2	.68	.37	.19	.50
T-50-2	.50	.30	.19	.45
T-37-2	.37	.21	.12	.40
T-25-2	.25	.12	.09	.30
T-12-2	.125	.06	.05	.25

Yellow "SF" Cores—10 MHz
to 90 MHz— $\mu = 8$

T-94-6	.94	.56	.31	.95
T-80-6	.80	.50	.25	.80
T-68-6	.68	.37	.19	.65
T-50-6	.50	.30	.19	.50
T-25-6	.25	.12	.09	.35
T-12-6	.125	.06	.05	.25

Black "W" Cores—30 MHz
to 200 MHz— $\mu = 7$

T-50-10	.50	.30	.19	.60
T-37-10	.37	.21	.12	.45
T-25-10	.25	.12	.09	.40
T-12-10	.125	.06	.05	.25

FERRITE BEADS: .125" x .125" $\mu = 900$. With Spec Sheet & Application Notes Pkg of 12, \$2.00

KILOWATT TOROID BALUN KIT: Still only \$5.00

EXPERIMENTER'S 2 CORE TOROID KIT—This famous kit contains cores, wire, and charts so that you can make your own high Q modern inductors for hundreds of practical applications. \$1.50

MINIMUM ORDER: \$1.00
Please Add 25¢ per order
for Packing & Shipping

AMIDON ASSOCIATES
12033 Otsego Street
North Hollywood, Calif. 91607

NEW

18th edition of THE WORLD FAMOUS Radio Handbook

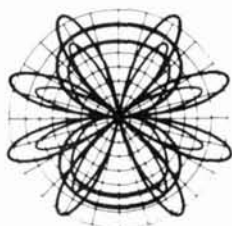

Only

\$13.50 postpaid

* The biggest selling book for the amateur and engineer market!

* Thoroughly revised and updated!

Over 800 pages tells how to design, build, and operate the latest types of amateur transmitters, receivers, transceivers, amplifiers, and test equipment . . . SSB Equipment . . . RTTY Circuits and Semiconductor Circuits.

Provides a Complete Understanding of:

- Circuits of newest development
- Test equipment
- Antennas
- Radio Mathematics
- Industrial and Military electronics

FOR DELIVERY EARLY IN 1970

ORDER TODAY

from

book division

comtec

Box 592 • Amherst, New Hampshire 03031

Pro-key Kit



Send perfect morse code — from 5 to 50 words per minute. Excellent to build up your code speed — anyone can send practice code.

- Self-completing characters with automatic character spacing.
- Precision kit includes all parts, such as metal case and printed circuit boards, and detailed, illustrated instructions.
- Pre-assembled keyboard with standard type-writer key arrangement and spacing.
- Self-contained battery operated — two standard "D" cells. All solid state.
- Built-in sidetone and speaker, fast acting relay output.

Basic Pro-Key Kit \$149.50 pp

Added Buffer Storage Kit \$34.50 pp

Micro-Z Co.

Box 2426 Rolling Hills, Calif. 90274

W2AU BALUN LETS ENTIRE ANTENNA RADIATE!

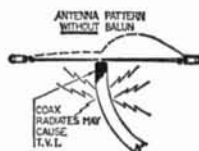
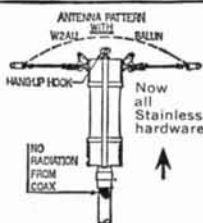

STOP WASTING YOUR SIGNAL! REMEMBER, YOUR ANTENNA IS THE MOST IMPORTANT PIECE OF GEAR YOU OWN.

- No Radiation from Coax
- No Center Insulator Needed
- Perfect for Inverted Vees (Use Hang-up Hook)
- Built-in Lightning arrester
- Broad Band 3 to 40 mc.
- Takes Legal Power Limit and then some
- Two Models:
1:1 50 ohm coax to 50 ohm balanced
4:1 75 ohm coax to 300 ohm balanced
- A must for Inverted Vees, Doublets, Quads, Yagis and Multiple Dipoles.

\$12.95 AMATEUR NET

See QST and May 73 for more details

W2AU Complete pretuned Fiberglass Quad \$99.95
W2AU Complete pretuned Vinyl Quad \$64.95

UNADILLA RADIATION PRODUCTS

Unadilla, N. Y. 13849 607-369-2985

WE PAY CASH FOR TUBES
LEWISPAUL ELECTRONICS INC.
303 W. Crescent Avenue
Allendale, New Jersey 07401

WORLD QSL BUREAU

5200 Panama Ave.
Richmond, Calif. U.S.A. 94804

PLAN 1

We forward your QSLs (please arrange alphabetically) to or within U.S.A., Canada and Mexico for 3¢ each, and to all other places in World for 4¢ each.

PLAN 2

You use our special log form and send us a copy. We supply QSL — make out QSL — deliver QSL, all for 8¢ each.

WRITE FOR FREE INFORMATION SHEET



**MIDLAND
SWR AND
POWER
METER**

Reads output and reflected power simultaneously. May be left in line up to 2000 watts. Low insertion loss. Size 5x2x2. Good to 175 Mhz. PRICE \$15.95, FOB HOUSTON.

MADISON ELECTRONICS SUPPLY

1508 McKINNEY — HOUSTON, TEXAS 77002
(713) 224-2668

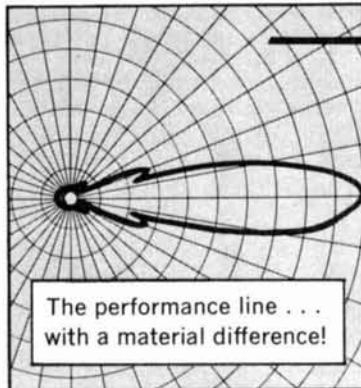

The performance line . . .
with a material difference!

telrex

PREFERRED AND SPECIFIED WORLD-WIDE BY
COMMUNICATION ENGINEERS AND ADVANCED AMATEURS

Don't settle for anything less than the very best! Use Telrex Communication products — for long lasting optimum performance and value!

FREE . . . Tech data and pricing catalogs describing off-the-shelf and custom-built antennas, systems, "Inverted-vee kits", towers, mono-poles and rotatable "Berthas".

For commercial and military applications write for CM69 . . . for amateur applications write for PL69.

COMMUNICATION SYSTEMS SINCE 1921 **telrex** Laboratories

Communication

Engineering

ASBURY PARK,
NEW JERSEY 07712, U.S.A.

Regul. Pwr Sply for Command, LM, Etc.

PP-106/U: Metered. Knob-adjustable 90-270 v up to 80 ma dc; also select an AC of 6.3 v 5A, or 12.6 v 2½ A or 28 v 2½ A. With mating output plug & all tech. data. Shpg. wt. 50 lb. **19.50**

BARGAINS WHICH THE ABOVE WILL POWER:

LM-(*) Freq. Meter: .125-20 mhz, .01% CW or AM, with serial-matched calib. book, tech. data, mating plug. Checked & grtd. **57.50**
 TS-323 Freq. Meter: Similar to above but 20-480 mhz. .001%. With data. **169.50**
 A.R.C. R11A: Modern Q-5'er 190-550 khz **12.95**
 A.R.C. R22: 540-1600 khz w/tuning graph **17.95**
 A.R.C. R13B: 108-132 mhz w/tuning graph **27.50**

High-Sensitivity Wide-Band Receiver

COMMUNICATIONS . . . BUG DETECTION
 SPECTRUM STUDIES

38-1000 MHZ: AN/ALR-5 consists of a brand-new Tuner/Converter CV-253/ALR in original factory pack and an exc. used, checked OK & grtd. main rcvr R-444 modified for 120 v, 50/60 Hz. The tuner covers the range in 4 bands and each band has its own Ant. input plug (type N). Packed with each tuner is the factory checkout sheet. The one we opened showed SENSITIVITY: 1.1 uv at 28.2 mhz, 0.9 at 133 mhz, 5 at 538 mhz, 4½ at 778 mhz, 7 at 1 ghz. The rcvr. is actually a 30 mhz IF ampl. with all that follows an IF, including an S meter. Has Pan, Video & AF outputs. Has a calibrated attenuator in 6 db steps to -74 db, also AVC position. Select pass of -200 khz or -2 mhz. AND SELECT AM OR FM! We furnish Handbook & pwr-input plug, all for **275.00**

SP-600-JX(*) Rcvr: 0.54-54 mhz. the popular late-type Hammarlund Super-Pro. aligned, grtd, exc. physical cond. too, w/book. **325.00**

R-390/URR Rcvr: Collins xtl-synthesizing dirtless receiver, grtd 100% perfect **795.00**

Versatile Plate & Filam. Transformer

Depot Spares for SP-600-JX: Pri. 95/105/117/130/190/210/234/260 v 50/60 Hz. Sec. 1: 305-0-305 v, 150 ma. Sec. 2: 5 v 3 A. Sec. 3: 6.3 v 5A. Sec. 4: 7½ v, 3/4 A. Sec. 5: 7½ v, 1¼ A. Legend for pins is plainly marked. Herm. sealed. **2.95**

We probably have the best inventory of good lab test equipment in the country. Scopes, Signal Generators, VTVM's, DVM's, RFI Meters, etc., etc. But, please do not ask for catalog! Ask for specific items or kinds of items you need! We also buy! What do you have? Right now we need some Beckman #7370 Counters, for example.

R. E. GOODHEART CO. INC.

Box 1220-HR, Beverly Hills, Calif. 90213
 Tel: Area 213, office 272-5707, messages 275-5342

New! SPEECH compressor

- Increase talk power drastically!
- Installs internally - always with you -
Fixed - Mobile - DXpeditioning!
- Works with Phone Patch
- Fully wired - not a kit
- No Holes 15 min. installation in
HW100, SB101, SB401 and others
- Full year warranty - free literature

MODEL RPC-3

\$24.⁹⁵

POSTPAID

R_p Electronics

BOX 1201

CHAMPAIGN, ILL. 61820

GET MONEY

Guaranteed top money for any piece of surplus equipment. Payment in 24 hours. We also pay shipping, insurance. Call collect or send list for quick quote. **SPACE ELECTRONCS CORP.** 11 Summit Ave. East Paterson, New Jersey, (201) 791-5050



BUGS ARE OK... keyers are better

Our **ELECTRONIC FIST** is the best!

\$49.00 for the kit, \$56.00 wired.....

Send 50¢ for the CONSTRUCTION MANUAL.

And see for yourself.....

GURMS ELECTRONIC DEVICES Dept. H, Box 4090, Mountain View, California 94040

ALL BAND TRAP ANTENNA!

Reduces interference and Noise on ALL Makes Short Wave Receivers. Makes World-Wide Reception Stronger. Complete with 96 ft. 72 ohm feedline. Sealed resonant traps. For novice and class radio amateurs! Eliminates 5 separate antennas with better performance guaranteed! 80-40-20-10 meter bands. Complete 102 ft. \$19.95. 40-20-15-10 meter bands. 54 ft. (best for world-wide short wave reception) \$18.95. Send only \$3.00 (cash, c.k. mol) and pay postman balance COD plus postage on arrival or send full price for postpaid delivery. Complete instructions included!

WESTERN ELECTRONICS Dept. B-12 Kearney, Nebr. 68847

WE PAY **HIGHEST**
 PRICES FOR ELECTRON
 TUBES AND SEMICONDUCTORS

H & L ASSOCIATES

ELIZABETHPORT INDUSTRIAL PARK

ELIZABETH, NEW JERSEY 07206

(201) 351-4200

LIBERTY PAYS MORE!!

WILL BUY FOR CASH — ALL TYPES
 Electron Tubes • Semiconductors • Test Equipment
 • Military Electronic Equipment

Wire, write, phone collect! We pay freight on all purchases!

LIBERTY ELECTRONICS, INC.

548 Broadway, New York, N. Y. 10012

Phone: 212/925-6000

DIODES

PIV	TOP-HAT 1.5 AMP	EPOXY 1.5 AMP	EPOXY 3 AMP	STUD- MOUNT 6 AMP
50	.04	.06	.12	.15
100	.06	.08	.16	.20
200	.08	.10	.20	.25
400	.12	.14	.28	.50
600	.14	.16	.32	.58
800	.17	.20	.40	.65
1000	.20	.24	.48	.75

PRICES PPD. U. S. A.

PA. RESIDENTS ADD 6% PA. SALES TAX

M. WEINSCHENKER K3DPJ

PO BOX 353, IRWIN, PA. 15642

— FREE TOOLS! FEBRUARY SPECIAL —

PRINTED CIRCUIT EDGE CONNECTOR

We have been lucky enough to obtain a large quantity of these connectors which take a 4"x5 1/2"x1/16" thick printed circuit board (or two 4"x2 1/2" boards side by side using a 1/2" center partition). The connector has 48 gold plated contacts, spaced on 0.200 inch centers, suitable for solder or wire w/cap connections. Manufactures O.E.M. Price for this connector is \$7.60 each. We have suitable unetched copper clad board approximately 4"x5 1/2" available to fit this connector as well as pre-tched Universal Logic cards described elsewhere in this ad. Take advantage of this special while they last. From what we have heard the gold alone is worth over 50 cents. **PCEC \$1.50 each, 10 for \$12.00, 100 for \$100.00** PCEC-BOARD Matching, approx. 1/16"x4"x5 1/2" Double clad board unetched 25 cents each, any quantity but only available with purchase of connectors.

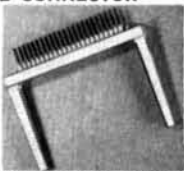

SYLVANIA TYPE 5ES INDICATOR LAMPS

These hard to get lamps are made to operate directly from the output of DTL or TTL Integrated Circuits. Draws only 40 milliamperes at 5 volts. Eliminate the complexity of using driver transistors and separate supplies and conserve power. Solder directly to P.C. Board. Brand new, factory fresh, packaged with full 7/8" leads. **...SSESIL 10 for \$4.00 pp**



USAF NAVIGATOR WRIST WATCH

These world renown 17 jeweled movements were made with exacting craftsmanship and mil-spec requirements. The watches were made by Bulova, Elgin, and Waltham with a hack mechanism by pulling the crown to stop the second hand; so the time may be set to the exact second. All are in good used condition with 24 hour luminous dial, St. St. case and expansion band. **USAF WW \$20.00 pp**



COMPUTER GRADE GIANT CAPACITORS



These brand new capacitors are in great demand as filter capacitors for I.C. Logic Circuits, Power Supplies, etc. These will take the noise out of the most stubborn circuits, where all else fails.

Net Price is from \$4.00 to \$18.00 each.

WT.	SIZE	PRICE EA.	12 FOR
2#	110,000mf 15V	\$2.00	\$20.00
2#	25,000mf 25V	1.50	15.00
1#	9,300mf 15V	1.00	10.00
2#	6,000mf 75V	1.50	15.00
1#	4,000mf 50V	1.00	10.00

SPEED CONTROL APPLIANCE SWITCH

This switch has three positions OFF — 1/2 ON — ON. The 1/2 ON control is obtained by a 3 amp 400 PIV diode wired across the switch. In the half speed position the diode is placed in series with the load. Priced at less than the value of the diode alone. **TSSS 2 for \$1.25 pp**



FREE TOOLS. If you place your order for \$10.00 or more worth of merchandise before March 1st we will give you a free surplus used high quality American made Kreuter or Utica long nose plier or small diagonal (no choice).

UNIVERSAL LOGIC CIRCUIT CARDS
Instant Logic!

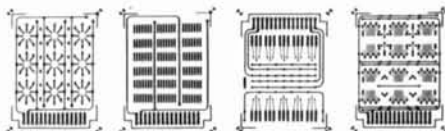

— LOGIC CIRCUIT BOARDS AVAILABLE —

- CB 8 T05 — for 9 — 8 pin T05 can I.C.
- CB DIP — for 9 — Dual-in-line I.C.
- CB FP — for 9 — Flat Pack I.C.
- CB FDC — for transistors & components.
- CB 10 T05 — for 9 — 10 pin T05 can I.C.

NEW LARGER BOARDS

Our previous Universal Logic Cards are still available as advertised, but for those of you who like to put more circuitry on a single board new varieties are available.

These boards are the most useful items we have ever offered, and one of the best sellers. We offer them at 1/5 the price of others. How? By using surplus connectors and copper clad board, and etching them in huge quantities. We have sold 10,000 of these boards in the past few months, and orders keep climbing as customers find out how useful they are. The use of the boards is simple. The board has a pattern etched on it for mounting integrated circuits. You drill out the desired hole pattern. The power leads are already routed around the boards. Discrete components and transistors can be mounted in the locations between the I.C.'s. Then you route the wires between the I.C.'s and to the connector, and you are ready to count compute or whatever. Here are the cards available: ILCC — original — pads for 14 pin dual-in-line on one side, 10 pin to 5 on the other, transistor pads on both sides as previously advertised, complete with a surplus PC card with edge connector, and mating connector. You take the connector off the surplus card, and throw it away (or salvage lots of useful components from it). Will mount four integrated circuits, and two transistors. Size 2 1/2"x2 1/4". See previous ad for illustrations.

- 2 Cards & mating connectors 2ILCC \$ 2.50 pp
- 10 Cards & mating connectors 10ILCC \$10.00 pp
- 100 Cards & mating connectors 100ILCC \$88.00 pp

LILCC-New larger size cards 3"x4" mounts 9 integrated circuits in pattern as illustrated above. Specify which type pattern you want. Pattern on one side only. Same connections and salvage board as ILCC provided.

- 2 Cards & mating connectors 2LILCC \$3.50 pp
- 10 Cards & mating connectors 10LILCC \$15.00 pp

SPECIFY PATTERN DESIRED

ULILCC-Still larger 4"x5 1/2" size, mounts 16 integrated circuits into edge connector PCEC shown on left of page

- 2 Cards & mating connectors 2ULILCC \$ 5.00 pp
- 10 Cards & mating connectors 10ULILCC \$22.00 pp

SPECIFY PATTERN DESIRED

Send 25¢ for catalog 703. Jam packed with surplus bargains . . . Best yet . . . Just fantastic . . . Free with an order.



Enterprises

P. O. BOX 44, HATHORNE, MASS. 01937

MORE OVERSTOCK

RANGE FILTER. Poor man's Q5-er. A **MUST** for CW & RTTY. Sloping front, black crackle finish. Has 2 jacks, for PL-55; 6' cord, w/PL-55; 3 position switch-"RANGE" passes 1020 cycle; "VOICE" rejects 1020 cycle; "BOTH" no filter action. NEW. 3# \$2.10 ea. 4 for \$8.00

VARIABLE CAPACITORS

5 gang, 2010 pf. 402 pf./sec. Ideal for output side, Pi-network. Will load 160 meter, without inductance to 1KW. $\frac{3}{8}$ " shaft, with 50:1 rt. angle drive. Take outs, excellent condition. 3#.

\$2.25 ea. 4 for \$8.75

EFJ #152-516. Dual, split stator, 40 to 475 pf./sec. 4500V. .125" spacing. Dual $\frac{1}{4}$ " shafts. 16 stator, 17 rotor plates. $5\frac{1}{2}$ " w, $5\frac{1}{4}$ " h, 16" l. 9#. NEW.

\$6.50 ea. 4 for \$25.00

50-150DQ45. 4 gang, split stator, 2 sec. 50 pf./sec. 2 sec. 150 pf./sec. 4500v. With switch will yield 50, 100, 150, 200, 250, 300, 350 or 400 pf. total. Dual $\frac{1}{4}$ " shafts. $4\frac{1}{4}$ " w, 4" h, 15" l. 6#. NEW.

\$6.50 ea. 4 for \$26.00

E#154-2. 15 to 353 pf. 2 KV. dual $\frac{1}{4}$ " shafts. NEW.

\$4.25 ea. 4 for \$16.50

MR TYPES, E JOHNSON; H HAMMARLUND
All 1 KV, dual $\frac{1}{4}$ " shafts.

E #149-5. 7.1 to 102 pf. srt. line capacity.

\$1.10 ea. 4 for \$4.25

E #149-6. 8 to 140 pf. srt. line capacity.

\$1.25 ea. 4 for \$4.75

H #MC-50M. 5.8 to 50 pf. srt. line capacity.

\$1.10 ea. 4 for \$4.25

5 to 20 pf. srt. line capacity. 75¢ ea. 4 for \$2.85

All prices are NET, FOB store, Chicago.

PLEASE include sufficient for postage.

Any excess remitted, returned with shipment.

B C Electronics

5696 North Ridge Avenue
Chicago, Illinois 60616

... Hours ...

Wed. and Sat., 10 a.m. to 3 p.m.
Other times, by appointment

... Phones ...

312-334-4463, if no answer please call 312-784-4426

Mailing Address for all orders, inquiries and correspondence: c/o Ben Cohn, 5058 North Claremont Avenue, Chicago, Illinois 60625.

BARRY PAYS CASH FAST

You can be sure with Barry . . .
Fair dealing since 1938

Send lists of your unused TUBES,
Receivers, Semi-Conductors,
Vac. Variables, Test Equipment, etc.

No Quantity too Small.
No Quantity too Large.

Write or Call now . . . BARRY, W2LNI

BARRY ELECTRONICS

512 BROADWAY • NEW YORK, N. Y. 10012
212 - WA 5-7000



FREE Catalog Of The WORLD'S
FINEST GOV'T
SURPLUS ELECTRONIC BARGAINS

Now **BIGGER** and
BETTER Than Ever!

MAIL THIS COUPON NOW

NAME: _____

ADDRESS: _____

CITY: _____ STATE: _____ ZIP: _____

For your FREE copy, fill out coupon and mail. Dept. HR

FAIR RADIO SALES
P. O. Box 1105 • LIMA, OHIO • 45802

FILAMENT CHOKE

Shielded high reactance at all frequencies above 3 mc. Current capacity of 30 plus amps. Voltage drop at 21 amps is less than .15 volt. Size $2\frac{1}{4}$ wide x $1\frac{1}{2}$ high x $5\frac{1}{4}$ long.

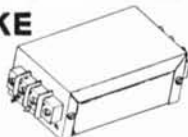

Pa. residents add 6% sales tax.

Price **\$7.95 ppd. U.S.A.**

M. WEINSCHENKER K3DPJ
BOX 353, IRWIN, PA. 15642
DEALER INQUIRIES INVITED

radio amateur

callbook

Radio Amateur
Emblems engraved
with your call letters.



Charm

Gold
 Rhodium
call letters
\$5.00 Ea.



Tie Bar

Gold
 Rhodium
call letters
\$5.00 Ea.



All illustrations
are actual size.

Lapel Pin

Gold
 Rhodium
call letters
\$5.00 Ea.

Rush Order To: RADIO AMATEUR CALLBOOK, Inc.
Dept. E. 925 Sherwood Drive, Lake Bluff, Ill. 60044

AN/ART-13 100-WATT XMTR

11 CHANNELS
200-1500 Kc
2 to 18.1 Mc

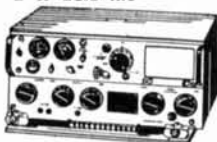

Collins Autotune Transmitter, extremely stable and suited for side band. Written up in QST Jan. issue 1964. Used. These are in boxes & crates as received from the Gov't & we will ship them out "as is" with no guarantee. They are supposed to be complete & with tubes. We are not even going to open the boxes and will simply stick a label on them and ship them out. We must make room for incoming material and our loss is your gain. #ART-13 \$15.00

HAMMARLUND APC CAPS

Midget style, brand new, 4.5-100 mmfd. 3/\$1.00 12/\$3.00

**APC GRAB BAG**

Unused assortment of various sizes and styles. Thousands on hand & bargain priced.

5/\$1.00 30/\$5.00

TOROIDAL CORES

Insulated powdered iron core about the size of 25¢ piece. Very low inductance, hi-freq. Wind your own transistor xmtrs.

#A-70 5/\$1.00 30/\$5.00

RF FERRITE CORE CHOKE

Hi-permeability, ultra midget style, coated for moisture resistance, color coded. Used in xmtrs, receivers, converters, TV-peaking. Brand new, worth 40¢ each. Assortment of 1.8, 27.0, 330 uh. Pack of 30, \$12.00 value.

#A-71 30/\$1.00 180/\$5.00

**TRANSISTOR MOUNTING PADS**

Round fibre glass insulating pads, used under 3 legged TO-5, TO-18, etc. Raises and insulates transistors from PC board. Permits longer leads to be used with less danger of heat destruction. Adds professional touch to finished circuits. Bag of 50 pre-drilled pads.

#A-3 50/\$1.00 300/\$5.00

SILVER MICAS

Misc. assortment of CM type small silver micas. Supply varies & will give a mix of available on-hand stock. Unused, long leads, standard codes stamped on each.

#A-4 30/\$1.00 180/\$5.00

**2 METER ARC-3**

Just uncovered a batch of the famous ARC-3 rcvrs & xmtrs with all tubes. Range 100-156 mc, 8 xtl channels. Cheap way to get on 2 meters, CD nets, MARS nets, etc. With conversion details. Rcvr \$15, Xmtr \$15;

both units \$25.00

PHOTOFLASH TRIGGER XMFR

Thordarson #22R44 brand new, produces 15KV pulse. With spec. sheets.

#22R44 \$1.75 each 10/\$15.00

FIBRE OPTICS KITS WITH IMAGE TRANSMITTER

An experimenters delight, fantastic display of the unique properties of clad-fibre-optics to pipe light as well as images. Kit #1 includes PVC sheathed bundle of glass fibres with polished ends (light pipe), bundle of plastic fibre optics, bundle of glass fibres, coherent light pipe (transmits images), instructions & experiments.

BLISS-FULL PAK #1 \$5.00

Kit # 2 includes all of the above but more fibres, longer lengths, fatter bundles and also includes light source, heat shrink tubing, a 5 ft. light pipe, a longer coherent bundle (image transmitter) & more experiments.

BLISS-FULL PAK #2 \$10.00

FLEXIBLE FIBER-OPTICS LIGHT GUIDES**FIBRE OPTIC LIGHT PIPE**

1 ft length jacketed glass fibres (200 fibres) each end sealed and optically polished for maximum light conduction. Pipe light around corners, into difficult locations, etc.

#LP-1 \$1.00

BULK LIGHT PIPE

3 feet of fibre glass (200 fibres) with jacketing. Make your own light pipes, Christmas tree displays, psychedelic lighting, etc. Any length you wish at 3 feet for \$1.00.

FIBRE OPTIC OPTICAL SCANNER \$5.00

Photo optics scanner, as used in IBM punch card scanner system. We offer the 12 position optical scanner consisting of 2 ft. assembly light pipe fanning out into a 12 channel scanner. All terminations optically polished. Make your own card scanner, light chopper, etc. A value for the 22 inch light pipe alone. With 4 page evaluation & application data. #LP-3 \$5.00



Above equipment on hand, ready to ship. Terms net cash, f.o.b. Lynn, Mass. Many other unusual pieces of military surplus electronic equipment are described in our catalog.

Send 25¢ for catalog #70

JOHN MESHNA JR.

19 ALLERTON ST., LYNN, MASS. 01904
P. O. BOX 62, E. LYNN, MASS. 01904

Advertisers iNdex

INTEGRATED CIRCUITS



New straight from factory Fairchild I.C.'s UL 914 with 30 project diagrams.

80¢ ea., 10/\$7.50 100/\$65.00
UL 923 J.K. flip-flop with spec. sheet.

\$1.50 ea., 10/\$13.50 100/\$110.00

14 pin FLAT PACK MC790P Dual JK Flip Flop.
\$2.00 ea. 10/\$18.95 100/\$179.50

COOLING FAN blower, 4 pole 110V 60 cyc motor with 4 bladed nylon fan. Very quiet, about 50 CFM. 2 1/4" W x 3" H x 2 1/4" D. Shipping weight 3#. \$2.25 ea. NEW



7 Tube 2nd IF Discriminator 455 KC IF 5 stages 2 stages limiting diode discriminator output ± 15 KC. \$3.00 ea.

1000 PIV 1 1/2 AMP EPOXY DIODES 40¢ EACH
10/\$3.75

SMALL HEAVY CHROME Cabinets. No front or back plates. 5 1/8" W x 2 5/8" D x 3 1/8" H NEW. 95¢ ea. 10/\$8.95

BUD METAL UTILITY CABINETS CU-1099 5" D x 6" W x 9" H, gray hammertone — one cover pre-drilled for other uses & one side not drilled. Shipping weight 4 lbs. NEW \$1.50 ea. 10/\$12.50

3 CHANNEL HIGH POWER COLOR CONTROL CENTER KITS



\$12.95

Any sound from a Hi-Fi, phono, radio, etc., may be fed into this unit. The PSA-3L will change the sound variations to light variations. 3 individual sensitivity controls are used for 3 separate channels each capable of accommodating 500 watts of external lights.

Color predominance can be obtained by adjustment of the corresponding sensitivity control. The PSA-3L is housed in a modern 2 piece Walnut finish aluminum case. Size 5" x 5" x 2 1/2". Simply plug lights into light sockets and run wire from speaker to this unit for psychedelic color. Shipping weight 1 lb.

Two Locations



R & R ELECTRONICS
311 EAST SOUTH ST.
INDIANAPOLIS, IN.
46225

R & R ELECTRONICS
1953 S. Yellow Springs
SPRINGFIELD, OHIO
45506

Please refer mail order to Ohio store.
Add sufficient postage, excess refunded.

Amidon Associates	87
BC Electronics	92
B & F Enterprises	91
Barry Electronics	92
Collins Radio Co.	Cover II
Communications Technology, Inc.	75, 88
Curtis Electro Devices	90
Dames Co., Ted	53
Drake Co., R. L.	2
Eimac Division of Varian	5
Fair Radio Sales	92
Goodheart Co., Inc., R. E.	90
Gordon Co., Herbert W.	96
H & L Associates	90
HAL Devices	86
Hallicrafters	69
Hammarlund Manufacturing Co.	23
Henry Radio	1
International Crystal Manufacturing Co.	39
Jan Crystals	86
Lewispaull Electronics, Inc.	89
Liberty Electronics	90
Madison Electronics Supply	89
Meshna, John, Jr.	93
Micro-Z Co.	89
Miller Co., J. W.	85
Military Electronics, Inc.	90
National Radio Co., Inc.	54
National Radio Institute	85
Newsome Electronics	81
Palomar Engineers	84
Phase Corp.	77
R&R Electronics	94
RCA Institutes	49
R P Electronics	90
Radio Amateur Callbook, Inc.	82, 84, 92
Radio Shop, Lab 1	84
Sentry Manufacturing Co.	24
Signal/One	Cover IV
Spectronics	Cover III
Spectronics, Inc.	79
Stellar Industries	82
Structural Glass, Ltd.	82
Swan Electronics	17
Telrex Communication Engineering Laboratory	89
Topeka FM Engineering	86
Unadilla Radiation Products	89
Vanguard Labs	87
Varitronics, Inc.	71, 95
Weinschenker, M.	90, 92
Western Electronics	90
World QSL Bureau	89

1970 ISN'T ALL THAT'S NEW...

Varitronics introduces the go anywhere, do anything, work everywhere

2 METER FM HANDIE-TALKIE The HT-2

No more versatility possible than this beautifully engineered transceiver. Powered with ni-cads, it comes complete with unbreakable ribbon antenna, battery charger, carrying-case, ear phones, ni-cad batteries, crystals for 146.34/.94 — .94/.94, and a barrel of fun with your local repeater.

Specifications:

General:

- Frequency coverage—any 500 KHz between 134-150 MHz
- Size— $1\frac{7}{8}$ " x $3\frac{1}{8}$ " x $8\frac{1}{4}$ "
- Weight— $2\frac{1}{4}$ pounds (includes case and antenna)
- Uses IC's Ceramic and Mechanical filters
- Two channels

Receiver:

- Sensitivity—0.4 uV or less @ 20 db of quieting
- Bandwidth— ± 8 KHz at 6 db

Transmitter:

- RF Output power—1.6 watts minimum
- Deviation—Adjustable ± 5 KHz to ± 15 KHz
- Spurious emission—At least 50 db below carrier



*Amateur Net 269.95
at your Local Dealers*

VARITRONICS INCORPORATED

3835 North 32nd Street • Suite 6 • Phoenix, Arizona 85018

See us at SAROC February 4th-8th



Only \$249.95

THE BEST DEAL IN OUR HISTORY

(NCX-500 5 bands, 500 watts for less than \$250.00)

Since we opened our door we have never had such an attractive ham opportunity!

We offer to hams, world wide, the famous National NCX-500 transceiver new at the thrifty price of \$249.95. With the companion AC-500 power supply the total price is only \$299.95; less than the price of Americas most popular kit.

Here are the salient features of this deal:

- Only fresh factory cartoned material offered.
- A full six months warranty provided.
- No trades considered at these prices.
- Prices quoted are FOB Harvard, Mass.
- Bank Americard, Master Charge or American Express accepted. Financing available through GECC.

f) Special overseas prices for sterling customers. This set works on 230 volts, 50 cycles.

g) Offer limited to first come first served. (Although we bought them all they will not last long.)

The National NCX-500 with its AC-500 currently sells at \$425.00 and \$99.00 respectively. Thus, this deal is both timely and thrifty. If you have waited because you could not afford a modern rig, here is your buy now; even while the rest of the world goes up on price.

If you are a beginner or even if you have a big rig and need a second one for a spare, the NCX-500 should be your cup of tea. Study the specs, read the magazine reviews but send in your order while our stock lasts.

PRICE SCHEDULE

NCX-500 with AC-500 (no spkr and no cabinet)	36 lbs.	\$299.95
NCX-500 with NCXA supply (spkr and cabinet included)	40 lbs.	\$319.95
NCX-500 with Linear Systems Universal Mobile power supply 400-12	28 lbs.	\$359.95
NCX-500 without supplies	15 lbs.	\$249.95
XC-28 plug in solid state Xtal calibrator (available February 15th 1970)		\$19.95

Shipments. Preferably via United Parcel Service, Railway Express or Parcel Post. Specify and include provisions for same otherwise charges will go COD.

SPECIFICATIONS

Frequency Coverage:

3,500 - 4,000 KHz, 21,000 - 21,500 KHz,
7,000 - 7,300 KHz, 28,500 - 29,100 KHz,
14,000 - 14,500 KHz,

(2 additional crystals at \$7.00 each to provide coverage of entire ten meter band.)

Power Input:

500 watts PEP SSB; 360 watts CW; 125 watts AM
Derated 20% for mobile operation.

Emission:

SSB upper 10, 15 and 20 meters. Lower 40 & 80

Output Impedance:

40 - 60 ohms minimum pi network.

Receiver Offset Tune:

Plus or minus 3 KHz.

Filter:

Crystal lattice filter 6-50 DB shape factor 2.2-1.

Dial Calibration:

5 KHz on all bands.

Tuning Ratio:

Excellent mechanical resolution with 45-1 rate.

Electrical Stability:

± 400 cycles in room ambient after 30 min. warm up.

Suppression:

Carrier —50 DB rejected side band —40 DB,
third order products —50 DB at full output.

Sensitivity:

.5 microvolts for 10 DB s/N in SSB mode.

Metering:

PA cathode in transmit, S units on receive.

Special Features:

Sidetone monitor, built-in code practice oscillator, incremental tuning.

Dimensions:

6 3/16" high by 13 3/8" wide by 11" deep.
Weights but 15 pounds.

Mobile bracket and instructions furnished at no extra charge

HERBERT W. GORDON COMPANY

Harvard, Massachusetts 01451 • Telephone 617 - 456 - 3548

"America's Largest Exclusive Ham Store"

\$229.95

C

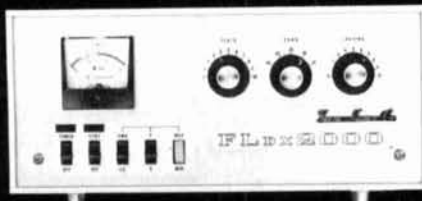

\$19.95

D

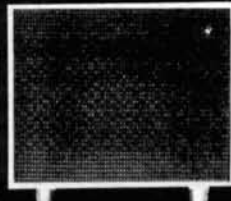

YAESU "F" LINE

\$99.95

B



\$449.95

A

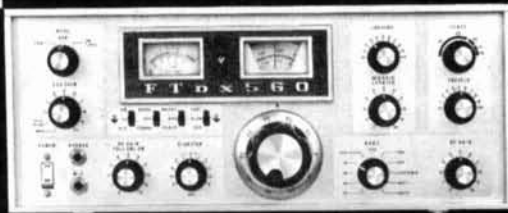

3 steps ahead

NOW, DIRECT TO THE AMATEUR. SPECTRONICS OFFERS PRECISION EQUIPMENT/DELUXE FEATURES/LOW COST

A FT dx 560 TRANSCEIVER

Best buy in a transceiver today, the FT dx 560 is a complete station in one package. Design features include zero backlash planetary tuning dial easily read to less than 500 cycles. Double conversion tunable I.F. system which results in drift free operation combined with high receiver sensitivity. Compare the features and specifications of this fully integrated transceiver before you make your next purchase.

Features: Built-in AC power supply, built-in VOX, built-in dual calibrators (25 and 100 KHz), built-in Clarifier (off set tuning), all crystals furnished 80 through the complete 10 meter band, provision for 2 additional auxiliary transceiver bands outside of the amateur frequencies, 10 MHz WWV receive band built in, break-in CW with sidetone, selectable USB & LSB.

Specifications: Maximum input: 560 W PEP SSB, 500 W CW. Sensitivity: 0.5µv, S/N 2C*Jb. Selectivity: 2.3 KHz (6 db down), 3.7 KHz (60 db down). Carrier Suppression: More than 40 db down. Sideband suppression: More than 50 db down at 1 KHz. Frequency range: 3.5 to 4, 7 to 7.5, 14 to 14.5, 21 to 21.5, 28 to 30 (megahertz). Frequency stability: Less than 100 Hz drift in any 30 minute period after warm up.

Complete only \$449.95

B FV-400S EXTERNAL VFO

Companion External VFO for the FT dx 560 Transceiver, the FV-400S enables cross band operation and provides the operator with separate receive transmit capability.

FV-400S features solid-state oscillator, buffer, and regulator. Covers frequency range from 8.4 to 8.9 MHz, and is powered by 6.3 volt AC supply. The same heavy duty gear Train is used in the VFO as in the FT dx 560 Transceiver. Frequency stability is less than 100 Hz drift in any 30 minute period

Complete only \$99.95

C FL dx 2000 LINEAR AMPLIFIER

Full 1200 W PEP SSB or 1000 W CW Linear compatible with any 30-100 W exciter. Features built-in solid state power supply, SWR bridge, manual or automatic exciter controlled relay. A.C. connection provided, forced air cooling, 117 or 220 V AC Operation optional, built-in low pass filter, grounded grid circuit.

Desk top size, 6 1/4" high, 14 1/2" wide 11 1/2" deep, weight approximately 40 lbs. Front panel is styled in nonspecular chrome with back lighted meter face and operating indicator lights. Heavy steel cabinet finished in functional blue gray.

Complete only \$229.95

D SP-560 SPEAKER

Matching heavy duty speaker completes the F Line Station. Unit is specially designed for voice-frequency range.

Complete only \$19.95

SPECTRONICS WEST

BOX 338 • LAKEWOOD, CALIF. 90714

SPECTRONICS EAST

BOX 1457 • STOW, OHIO 44224

Write for literature or order direct from Spectronics

Spectronics warrants the F Line for a period of one year after date of sale. Limited warranty is available for other models.

It's no secret ...

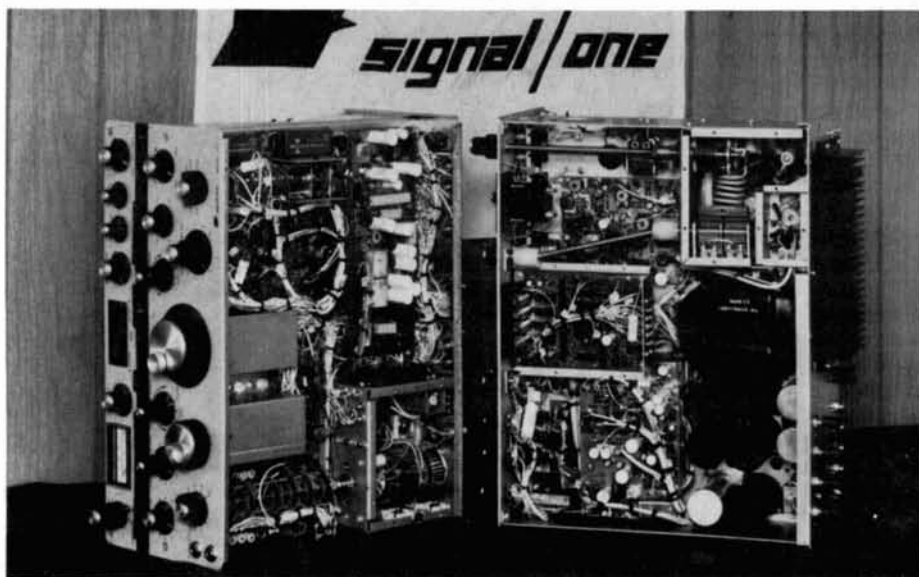

The *signal/one* CX7

CENTER OF ATTENTION at twenty major ham conventions last year . . .
Maybe you saw it ... even operated it. But if the crowd kept you from getting a *really good look*, here are highlights of the inside story of ...
the "DELUXE INTEGRATED STATION" ...

PERFORMANCE ... built in

- Dual-gate MOSFET receiver
- Ultra-sharp selectivity
- IF Shift (to slice off QRM)
- 300 watts input *all* modes
- RF clipping (for maximum *punch*)
- Pre-IF noise blanker

CONVENIENCE ... built in

- Instant band change *without tune-up*
- Frequency readout direct to 100 Hz
- Transceiver *plus* auxiliary receive
- Dual VFO's (for *split* operation)
- *True break-in* CW, silent VOX
- Integral AC supply *and* CW keyer

COVERAGE... built in

- All ham bands 10 *thru* 160 meters
- Full 1 MHz bands cover WWV, MARS
- All popular modes ... SSB, CW, FSK.

QUALITY ... built in

- Glass-epoxy etched circuit boards
- Instrument-grade components
- Continuous duty at full ratings
- Modularized construction

TO GET THE FULL STORY ...
write for an illustrated brochure.

It Speaks for Itself
signal/one

A Division of ECI (An NCR Subsidiary)

2200 Anvil Street N. • St. Petersburg, Florida 33710